

September 2007

Volume 29 Number 3

President's Letter

Camilla Van Vooren

By the time you receive this September WAAC *Newsletter*, I hope I will have seen you at the annual meeting in Denver. I extend my sincere appreciation to colleagues who presented papers at the meeting. I encourage all of you to consider sharing an interesting, challenging, or unique project with the WAAC membership at the next annual meeting. The comfortable, friendly, and supportive atmosphere of this gathering of professionals makes it a perfect setting to share our experiences: the good, the bad, and the ugly (and I might add the odd...).

I would like to take this opportunity to thank a number of individuals: Carl Patterson, the entire staff of the Conservation Department of the Denver Art Museum and all of my Denver colleagues for their assistance in planning the meeting, Yosi Poseilov for agreeing to give the workshop on digital photography, Ann Daley and Steve Good for making the tours of the Red House and the Anschutz Collection possible, and Carmen Brian and the Western Center for the Conservation of Fine Arts for hosting the opening reception at the Kirkland Museum.

A special thanks, as well, to my fellow WAAC board members, especially my Vice President, Susanne Friend, Treasurer, Membership Secretary and Member-at-Large, Chris Stavroudis, *Newsletter* Editor, Carolyn Tallent, Webmaster, Walter Henry, and Presidents Emeritus, Laura Downey Staneff, Beverly Perkins, and Molly Lambert for their continued helpfulness, patience, and support during my term. Planning the annual meeting can be, at times, an arduous task. The suggestions, advice, and encouragement of these individuals were invaluable to me. I would also like to recognize vendor donations from Dry Creek Gold Leaf, Inc. of Denver and Terry Dowd, Inc. whose generous contributions helped to defray meeting costs.

Continuing the theme of my previous letters focusing on the art scene in Denver, I will indulge in a discussion of the future of Denver's dynamic cultural growth. I recently attended a lecture at the Denver Art Museum given by Dean Sobell, the director of the future Clyfford Still Museum to be built by 2010 on Bannock Street, next to the Hamilton Wing of the Denver Art Museum. Sobel's lecture entitled "Who Is Clyfford Still... And Why Does He Matter" was a prelude to the exhibit at the Denver Art Museum, *Clyfford Still, Unveiled: Selections from the Estate* which opened July 14.

Attendees to the annual meeting will have had the opportunity to see this sampling of the Clyfford Still Museum's holdings: the thirteen paintings and works of art on paper are a respectable survey of the artist's oeuvre, which includes a striking self-portrait and the black and red-streaked *1944-N No.1* of which Sobel claimed, "I could argue that this is the first work of Abstract Expressionism."

Despite his early enthusiasm, Still retreated from the movement due to his disenchantment with galleries, the market, and the art world, in general. He went into virtual seclusion from commercial galleries in the 50s, while his contemporaries De Kooning, Pollock, Rothko, Newman, and others went on to further define the movement in a wide variety of styles. Meanwhile, Still left New York to live out his life in Maryland. Despite his reticence, the Met's exhibit of Still's work in 1979, the year prior to his death, was the largest body of work by a living artist ever exhibited there.

The artist's will placed rigid restrictions on the estate (encompassing nearly 95% of the artist's body of work and his entire archives) including the stipulation that the works could only be exhibited in a gallery built to his specifications. These specifications made various American cities reluctant to take on the responsibility of the estate and resulted in keeping his work from public view since 1980. In 2004, the city of Denver committed to carrying out the artist's wishes with its proposal to build the Clyfford Still Museum and was awarded with the estate. In

Contents

President's Letter	1
Regional News	4
Technical Exchange	8
A Novel Approach to Cleaning II: Extending the Modular Cleaning Program to Solvent Gels and Free Solvents, Part 1	9
<i>by Chris Stavroudis and Tiarna Doherty</i>	
Protecting Collections in the J. Paul Getty Museum from Earthquake Damage	16
<i>by McKenzie Lowry, BJ Farrar, David Armendariz, and Jerry Podany</i>	
AYMHH	24

President's letter, continued

2006, architect Brad Cloepfil, who recently completed the expansion of the Seattle Art Museum, won the commission to build the museum.

The Clyfford Still Museum will be preceded by the opening of another new cultural institution in Denver, the Museum of Contemporary Art, now under construction and scheduled to open in October. The MCA was formed in 1996 and was first housed in an old fish market in Sakura Square, an Asian market downtown. It moved to the "Temporary Contemporary" across the street from the new building site last year.

The selection process for the new museum took the form of a six-week educational interview during which six architectural designs were presented in lectures attended by graduate students, museum patrons, high school students, and others numbering to 900 per session. Director Cydney Payton describes the goal of the interview process "...to design a place where architecture supports rather than defines the museum's mission." Ghana-born British architect, David Adaje, was the unanimous choice resulting from the "public interview."

Adaje, known for his innovative use of light and symmetry, creates a dynamic between the glass-cloaked exterior and an interior described by the architect as a three volumes wrapped in a translucent skin (polypropylene). The light permeability and insulating properties of the polypropylene as well as the rooftop garden contribute to the structure's designation as a LEED structure (the first museum in the country with this certification). LEED, Leadership in Energy Environmental Design, is a nationally accepted building rating system which is the standard for the construction and operation of "green" building. LEED certification is based on compliance in five areas: sustainable site development, water savings, energy efficiency, materials selection, and indoor environmental quality. The structure will use approximately 40% less energy than a non-LEED building.

Adaje's design will house five distinct galleries that will feature works of art on paper, photography, oversized works, new media, and projects. It will be what Payton calls "a flexible space" where a minimalist entryway rises up to a threshold which dissolves into public and gallery spaces within.

I am happy to have been WAAC president at a time that gave me the opportunity to host the annual meeting in Denver when the city is experiencing what could be called a cultural renaissance. I hope that meeting attendees enjoyed both the public and private collections that were available to them as well as other Denver attractions during their visit here, and I hope that they will be encouraged to return to Denver to experience these new institutions in the Mile High City.

Carson Carrlee
(Ellen and Scott)



only pictures of Board Members' children are printed in the Newsletter

Volume 29 Number 2 WAAC Newsletter

WAAC Newsletter (ISSN 1052-0066) is a publication of the nonprofit Western Association for Art Conservation (WAAC). It is published three times per year, in January, May, and September. WAAC Newsletter is printed on alkaline paper. Copyright 2005 Western Association for Art Conservation.

EDITOR

Carolyn Tallent

REGIONAL NEWS

Susanne Friend

TECHNICAL EXCHANGE

Albrecht Gumlich

HEALTH & SAFETY

Chris Stavroudis

ARTICLES YOU MAY HAVE MISSED

Susanne Friend

COPY EDITOR

Wendy Partridge

Photocopying

To make academic course packets that include articles from WAAC Newsletter, contact the authors of the articles directly.

Note to Authors

Authors of articles and other contributions accepted for publication in WAAC Newsletter assign to WAAC Newsletter the right to publish their work in both print and electronic form and to archive it and make it permanently retrievable electronically. Authors retain copyright, however, and may republish their work in any way they wish.

Disclaimer

The Western Association for Art Conservation does not recommend particular individuals, businesses, treatments, products, or services. WAAC Newsletter is simply a vehicle for the presentation of information from various sources. Publication of articles or reports in the Newsletter should not be construed as an endorsement of their content by WAAC. Opinions expressed in articles published in the Newsletter are those of the authors.

Deadline

Contributions for the September Newsletter should be received by the Editor before **August, 2007**.

Western Association for Art Conservation

The Western Association for Art Conservation (formerly, the Western Association of Art Conservators), also known as **WAAC**, was founded in 1974 to bring together conservators practicing in the western United States to exchange ideas, information, and regional news, and to discuss national and international matters of common interest.

PRESIDENT

Camilla Van Vooren

VICE PRESIDENT

Susanne Friend

SECRETARY

General Information
New Memberships
Publication Orders

Teresa Moreno

TREASURER

Change of Address
Payments

Chris Stavroudis

MEMBERSHIP SECRETARY

Chris Stavroudis

MEMBERS AT LARGE

Scott Carrlee
Leslie Rainer
Chris Stavroudis
Marie Svoboda

WEB EDITOR

Walter Henry

PUBLICATIONS FULFILLMENTS

Donna Williams

Individual Membership in WAAC costs \$35 per year (\$40 Canada, \$45 overseas) and entitles the member to receive the WAAC Newsletter and the annual Membership Directory, attend the Annual Meeting, vote in elections, and stand for office. Institutional Membership costs \$40 per year (\$45 Canada, \$50 overseas) and entitles the institution to receive the WAAC Newsletter and Membership Directory. For membership or subscription, contact the Secretary.

Internet

Articles and most columns from past issues of WAAC Newsletter are available on-line at the WAAC Website, a part of CoOL (Conservation OnLine) hosted by Stanford University Libraries, at <http://palimpsest.stanford.edu/waac/>.

New Tools from Heritage Emergency National Task Force

A new collection of handy tools designed especially for libraries, archives, museums, historic sites, and historic preservation and arts organizations has been released by the Heritage Emergency National Task Force. The tools are the result of the Task Force's "Lessons Applied" initiative to develop practical applications for the lessons from Hurricane Katrina, such as helping cultural institutions apply for disaster aid and developing relationships with emergency responders. The new tools are available as free downloads at <http://www.heritagepreservation.org/PROGRAMS/TFResources.html>

Tips for Working with Emergency Responders.

Getting to know local emergency responders and how they work before disaster strikes can help keep staff and collections safe. This handy sheet tells how to find and build relationships with emergency responders, as well as what information needs to be exchanged to help responders protect cultural institutions.

Guide to Navigating FEMA and SBA Funding.

This concise Web site leads cultural institutions through the process of applying to the Small Business Administration (SBA) and FEMA for assistance after major disasters. Links put policies, application forms, and other necessary paperwork at the user's fingertips along with simple, step-by-step instructions for the application process.

MayDay.

MayDay is an annual event that encourages cultural institutions to undertake one simple emergency preparedness task. Created by the Society of American Archivists, MayDay was expanded in 2007 to include libraries, museums, and arts and historic preservation organizations. This year hundreds of organizations promoted the message, and FEMA featured MayDay on its Web site. The Task Force has produced a list of suggested MayDay activities, as well as promotional materials. Recommended Professional Emergency Management Training.

Most staff members want to help in the aftermath of an emergency at their institutions or in their communities. The free courses listed in this resource teach cultural heritage staff and volunteer teams about local, state, and federal disaster response frameworks already in place, as well as official protocols and structure, terminology, and key local contacts.

Panels composed of Task Force members and other experts have been working since October 2006 to prepare new resources and develop longer-term recommendations in the areas of incentives for preparedness, working with first responders, effective regional response, funding, and coordination among service organizations. The Task Force met July 17, 2007, to announce the new tools and discuss results of a member survey on Katrina, which will help the group prepare for future events. Other proposed initiatives include a preparedness poster, speakers' bureau on cultural heritage emergencies, guidelines for mutual assistance networks, GIS standards for cultural collections, a collections stabilization fund, and a new Foundation Center guide identifying disaster resource.

Membership

*Chris Stavroudis
membership secretary*

WAAC welcomes the following new members and late renewals.

Contact information is printed in the 2007 WAAC Membership Directory and the new members are listed here by name only.

ALIC: Archives Lib Info Ctr, Auckland War Memorial Museum Library, Vincent Beltran, Wendy Bennett, K. Elizabeth Brown, Liz Brown, John W. Burke, Lisa Capano, Lynn A. Davis, Linnaea Dix Dawson, A. Jane Dosman, Terry Dowd, Len Evans, Allyson Feeney, Robert Feller, John A. Fidler, Amy Green, Solomon R. Guggenheim Museum Conservation Department, Arlen Heginbotham, John Hirx, Judy Jungels, Gina J. Laurin, Patricia Leavengood, Gordon A. Lewis, Jr.,

(continued p. 7)

Regional News

ALASKA

Scott and Ellen Carlee welcomed a new addition to their household. Carson Orion Carlee was born on August 20 and weighed 8 lbs. Mother and baby are doing fine. In conservation news, Ellen was very pleased with the success of the Basketry Internship project which brought two interns, **Molly Gleason** from the Getty/UCLA program and **Samantha Springer** from the Winterthur/Delaware program to Alaska to work on baskets and collaborate with local basket makers. Scott continues to work on preventive conservation outreach for the state of Alaska and is very pleased to have been elected VP of WAAC.

Monica Shah also welcomed a new addition to their household as they adopted a daughter from India. Monica continues to establish the first conservation lab at the Anchorage Museum and is ordering equipment and working on exhibit loans.

Regional Reporter:
Scott Carlee

ARIZONA

The 'other WACC' is no more. The National Park Service's Western Archeological and Conservation Center in Tucson is now the Intermountain Region Museum Services Program. This name change hopefully dispels the common misconception that our conservation labs deal primarily with archaeology!

NPS conservators **Gretchen Voeks** and **Brynn Bender** have been working on pesticide testing projects for collections of natural history specimens and NAGPRA items. Brynn, **Audrey Harrison**, and **Maria Lee** continue to perform treatments for the Grand Teton National Park's Vernon collection of Native American items.

Maggie Kipling is completing treatments on prehistoric ceramics and textiles from Tuzigoot NM and working on a condition survey of objects from Manzanar NHS.

Martha Winslow Grimm continues organizing volunteer Angels Projects for the Costume Society of America. A successful project of processing artifacts for storage was held in May at the Guy B. Woodward Museum in Ramona, California. Next year's Angel Project will be held at Jackson Barracks, a military museum in New Orleans, LA. The museum

took on 12 feet of water during Hurricane Katrina submerging their artifacts. The CSA volunteers will be at the museum on May 20th to help out with their military uniforms and flags.

Nancy Odegaard and **Teresa Moreno** taught an introduction to archaeological conservation class at the University of Arizona in the Pre-Summer Session. This is the second year that they have offered this class, and it has been very successful. Nancy and Scott Carlee taught their materials characterization class at the Royal Danish Academy of Fine Arts Conservation Program in Copenhagen in June. In July, Nancy worked with Vicki Cassman on the Chinchorros mummies in Chile. After completing her tenure as President of AIC this past spring, Nancy is currently enjoying a well-earned sabbatical and is working on various other research projects. She will spend the fall at the Villa as a Getty Research Scholar.

Teresa Moreno is filling in as Acting Head of the Preservation Division at ASM while Nancy is away for the year. This summer, Teresa worked as site conservator for the second season of excavation at the Sanctuary of Zeus at Mt. Lykaion in Greece. She is currently working on the conservation of over five hundred objects for an upcoming exhibit entitled *Set in Stone* that will highlight Native American jewelry production and use in the Southwest. This work includes XRF and X-radiography to characterize the materials and technology.

Chris White has recently returned to ASM from Italy where he worked at the site of Poggio Colla on archaeological material. He is returning to the Pottery Project and is currently focusing on the identification of adhesives and organic residues on the museum's ceramics collection.

Caitlin O'Grady is completing her Kress Fellowship and will continue working in the ASM Conservation Lab as a National Science Foundation IGERT Fellow in Archaeological Science. She will continue working on her PhD research on the *Journeys of Our Ancestors: Migrations in the American Southwest* exhibit, scheduled to open September 2011. The ASM Preservation Division is pleased to announce the hire of **Gina Watkinson** as the new Administrative Assistant for the Division and the Conservation Lab. Gina came to ASM from Delaware where she graduated with a BA in Collections Management.

Regional Reporter:
Gretchen Voeks

GREATER LOS ANGELES

The Natural History Museum is pleased to host **Jennifer Kim**, a final year conservation graduate student from the NYU program, for a nine-month internship. Starting in September, Jen will be working with conservator **Tania Collas** and conservation technician **Kathleen Olson** to prepare Hispanic costumes and other objects for a new permanent exhibit.

In Decorative Arts and Sculpture Conservation at the J. Paul Getty Museum, **Julie Wolfe** has been collaborating with the Roy Lichtenstein Foundation in New York related to the Getty's outdoor sculpture by the artist entitled *Three Brushstrokes*. **Tom Learner** and **Alan Phenix** from GCI are also working on the project to develop a guideline for accurately repainting Lichtenstein's outdoor painted works.

Brian Considine, Julie Wolfe, and mountmakers **Adrienne Pamp**, **Mark Mitton**, and **Stephen Bell** are working on a temporary exhibition of the Cleveland Museum of Art's medieval art collection including over 130 works that will open in Sept. 2007. We are extremely happy to announce that **Katrina Posner** has joined the lab as a permanent staff member. Graduate Intern **Stephanie Grossman** will be joining the department for one year. A graduate of the conservation program in Cologne with an emphasis on modern sculpture, Stephanie is currently an MA candidate at the Technische Universität Berlin.

René Boitelle, a paintings conservator from the van Gogh Museum in Amsterdam, who is among others, responsible for the Museum Mesdag, is a guest of the Paintings Conservation Department for the Fall. He will be carrying out the study and treatment of a large Daubigny landscape from the Mesdag Museum, as well as working closely with other members of the department on the study and treatment of a second Daubigny landscape and a Courbet portrait. René will be working with the GCI on the technical studies of these pictures as well as three landscapes by Rousseau which are also in the studio (one of which is a recent Getty acquisition).

Sue Ann Chui is continuing with structural work on Nosadella's *Madonna and Child* from the Norton Museum of Art in Palm

Beach, Florida. She has also completed a comparative technical essay on a small painting of St. Ursula attributed to Agnolo Gaddi from the Santa Barbara Museum of Art which will be included in a forthcoming exhibition catalog on Cennino Cennini at the Gemäldegalerie, Berlin. **Tiarna Doherty** is working on a large painting of a tiger by Oudry from the Staatliches Museum Schwerin. The painting has large tears and areas of blanching thought to be from moisture damage.

Laura Rivers has accepted the position of Assistant Conservator of Paintings at the Menil Collection in Houston. She starts her new position in October.

Ellen Pearlstein from the UCLA/Getty Archaeological and Ethnographic Conservation Program reports that their students participated in a variety of internship projects this past summer. **Christian de Brer** returned to the Tarapaca Valley Field School in Tarapaca, Chile where he worked on mummy bundles and finds excavated in the valley. **Molly Gleason** worked on a basketry conservation project at the Alaska State Mus. in Juneau and the Sheldon Jackson Mus. in Sitka. She prepared baskets with a Tlingit weaver. **Allison Lewis** joined the Southern Methodist University's excavation at Poggio Colla in the Mugello Valley, Italy. She worked as a conservation intern cleaning, reconstructing, and rehousing a variety of objects. **Ozge Gencay Ustun** worked in the Objects Conservation Lab, Conservation Center at the Los Angeles County Museum of Art. **Liz Werden** attended the Flinders University's Rock Art Field School in Australia.

During the 2007-2008 academic year, the students will focus on the following internship projects: **Christian de Brer** will work in the Getty Conservation Institute's Field Projects section on mosaics under the direction of Thomas Roby. **Molly Gleason** will join the Anthropology Conservation Laboratory at the Smithsonian's National Museum of Natural History (NMNH) where her work will focus on a special loan of NMNH Native Alaskan collections to the Anchorage Museum and Arctic Studies Center. **Allison Lewis** will be working on archaeological and ethnographic objects from a number of different cultures and periods at the University of Pennsylvania Museum of Archaeology and Anthropology. **Steven Pickman** will be the Neukom Family Foundation Intern at the U.S. Holocaust Memorial Museum,

Washington, D.C. where he will work on historic collections. **Ozge Gencay Ustun** will work at the Southwest Museum of the American Indian, Autry National Center in Los Angeles, California, where she will work on a large scale collections move as well as exhibitions and loans. **Liz Werden** will begin her internship with the Getty Conservation Institute's Field Projects section, focusing on documentation with **Rand Eppich**. They welcome the following students into the Fall 2007 class: **Siska Genbrugge**, **Lauren Horelick**, **Jiafang Liang**, **Linda Lin**, and **Suzanne Morris**.

Rosa Lowinger's 1999 *Sculpture Magazine* interview with Cuban artists Los Carpinteros has been published in a new book by the International Sculpture Center Press titled "Conversations on Sculpture." The book, which contains interviews with such seminal figures as Richard Serra, Anthony Gormley, Lynda Benglis, James Turrell, and Maurizio Cattelan, among others, contains valuable information relating to the conservation of these artists' works. It is available through ISC or from Amazon.

Regional Reporter:
Virginia Rasmussen

NEW MEXICO

David Rasch has been promoted to the position of Director of the City of Santa Fe new Historic Preservation Division within the Land Use Department. He was previously the Historic Preservation Officer for the city. Santa Fe is celebrating the 50th year since the establishment of its historic preservation ordinance, making it the second oldest historic preservation ordinance in the country. **Patricia Morris** spent a week in July in Helena, Montana doing a survey of 40 rare maps at the Montana Historical Society. She also hosted a get-together for all of the local conservators and their families in June.

New Mexico State U. has announced that they are now the second university, after University of Delaware, to offer a four-year undergraduate museum conservation degree. This degree is offered through the art department as either a Bachelor of Arts or a Bachelor in Fine Arts degree. **Silvia Marinas** is the director of this program.

Angelyn Bass-Rivera and **Lauren Meyer** from the NPS along with **Conor McMahon** and **Larry Humetewa** of the Department

of Conservation of the Department of Cultural Affairs were featured in an article, "Racing Against Time" in the June 9, 2007 issue of the *Santa Fe New Mexican*. The article discussed the on-going conservation work at Bandelier National Monument.

Senior Conservator **Maureen Russell** has been working on several exhibitions including *Excavating Egypt: Great Discoveries from the Petrie Museum of Egyptian Archaeology* for the New Mexico Museum of Art, *Walang Kulit: Indonesian Shadow Puppets* for the Museum of International Folk Art, and *Santa Fe Style* for the Museum of Indian Arts and Culture.

Anya McDavis Conway recently finished her third year internship at the Conservation Department of the New Mexico Department of Cultural Affairs. Anya graduated with her Masters of Science from the University of Delaware graduate program. We are delighted that Anya will be staying with for another year. Anya will continue working on the Girard re-housing project for Museum of Indian Arts and Culture as well as many other projects and exhibitions.

In May, **Joe Sembrat** led a workshop on care of outdoor sculpture as part of the training for the Sikh Dharma as they prepare to open a museum at their main ashram in Española, NM. Museum Development Associates and their technical director, **M. Susan Barger**, have been working with the Sikhs for over a year on the museum.

Regional Reporter:

PACIFIC NORTHWEST

The Royal BC Museum has been very fortunate to host **Jane Kemp**, a conservation intern from the UK. Jane has assisted with monitoring and occasional artifact replacements in the summer blockbuster exhibit, *Titanic: The Artifact Exhibition*. She also participated in the condition reporting and mount preparation for next year's large in-house exhibit celebrating BC's 150th anniversary as a crown colony. Jane's greatest potential contribution, however, is her research into PEG impregnation of waterlogged archaeological basketry.

Treasures of the Tsimshian currently showing at the Art Gallery of Ontario and soon to be at the Canadian Museum of Civilization, marked the first traveling exhibit for which digitized conservation

Regional News, continued

documentation, including digital photography and condition reports, was mastered by RBCM staff.

The RBCM completed XRF testing for pesticide residues in a collection of First Nations artifacts which may soon be repatriated. Many thanks to the UBC Museum of Anthropology for their support and cooperation on this project. Work continues on the engineering of new cold and cool storage vaults. Construction is scheduled to begin in the new year.

Tania Ainsworth will be joining the RBCM this fall as a Sir Sanford Fleming College intern. The RBCM also recently welcomed back **Jana Stefan**, a previous Fleming intern, who is assisting in the Archives Lab, with the help of former Archives conservator, **Barry Byers**, while **Betty Walsh** is on leave until September.

Susan Lewandowski (from the Seattle Art Museum Conservation Department) and **Rina Luzius** (from the Burke Museum, University of Washington) have been interning with Alice Bear Conservation.

Dana Senge, of DKS Conservation Services, has been working with the National Parks Service for the past few months assisting with stabilization treatments of artifacts from the Gettysburg collection. She has had the pleasure of working with a wide variety of treatment issues as well as the wonderful folks at the Harpers Ferry Conservation Center in West Virginia.

The Washington State Arts Commission's (WSAC) Art in Public Places Program has hired **Adam Fah** to fill the newly created half-time position of Conservation Technician. Adam will be working under the Collections Manager facilitating conservation projects, art handling, and partner agency training for the care of more than 4600 artworks located throughout Washington, as well as helping to shape a conservation review process for new acquisitions to the State Art Collection. Since 2000, Adam has owned and operated a studio specializing in conservation and restoration of metal sculpture. He has been a professional patineur for the past 9 years and currently enjoys facilitating bronze castings for artist Philip McCracken.

The WSAC Art in Public Places Program is also organizing a traveling exhibition of Jacob Lawrence's series *The Legend of John Brown* from the State Art Collection. The exhibition tour brings this body of work

to community college galleries around the state, making the works accessible to audiences across Washington. *The Legend of John Brown* has been seen by audiences in the Tri-Cities, Vancouver and will open in Olympia in September and visit the Skagit Valley in early 2008. The tour is funded by the Washington State Arts Commission and the American Masterpieces initiative of the National Endowment for the Arts.

Following the opening of Seattle Art Museum's new downtown galleries and Olympic Sculpture Park, conservation intern **Sarah Kleiner** has commenced studies at the conservation Winterthur/University of Delaware Masters Program in Art Conservation. Conservation technician Susan Lewandowski is traveling to St. Andrew's University in Scotland for the Postgraduate Masters course in Museum and Gallery Studies.

In September, the SAM conservation department welcomed a new coordinator, **Jenny Söderlund**.

This fall, SAM conservation and registrars will collaborate with the University of Washington, teaching artists' techniques to graduate students in the Fine Arts Department and teaching the art lab for the Museum Collections Management course of the Museology Masters program.

Jack Thompson has completed CAP surveys for both the World Kite Museum in Long Beach, WA and the Oregon Jewish Museum in Portland, OR. He has also had the pleasure of working on a few family treasures: a family bible that was stolen in 1943 and recovered just last year at a genealogical library in Vancouver, WA and a fiddle and fiddle case belonging to his great-grandfather. The bible has been treated and the family records inside updated, and the fiddle case is currently undergoing restoration.

Regional Reporter:
Dana K. Senge

ROCKY MOUNTAIN REGION

Camille Moore, who recently graduated from the NYU conservation program, has joined Silverpoint Art Conservation, LLC as Assistant Conservator. She and **Laura Staneff** are working on a large group of photogravures by Edward Curtis.

Victoria Montana Ryan has recently

been named vice-chair for the AIC/CIPP specialty group. She also gave a presentation at the workshop "The Chemistry of Conservation" held at Colorado College. She attended the Canadian Association for Conservation annual meeting in St. John's, Newfoundland this past May.

Denver Art Museum conservation staff regret to announce that third-year intern **Julie Parker** will have left us for a wonderful job in Omaha NE at the Gerald Ford Conservation Center. She will be missed, but not forgotten. On the other hand, we are pleased to announce that **Elizabeth Homberger** from Buffalo State College will take her place in the lab. Welcome Liz. Lab staff will be growing soon when we fill two new positions approved for next fiscal year- a conservation technician and a paper conservator.

Plans for the new Clyfford Still Museum continue to evolve. The DAM is currently hosting a small retrospective of his work.

In addition to the WAAC conference, Denver is to host the AIC and AAM conference meetings. DAM conservation staff are involved in all three for local arrangements and conference content.

One year after the opening of the new Fredrick C. Hamilton addition, designed by Daniel Liebeskind, conservation staff are again hard at work preparing yet more material for rotations and new exhibits.

Regional Reporter:
Paulette Reading

SAN FRANCISCO BAY AREA

A volunteer firefighter in her spare time, **Debra Fox** is familiar with works of art in structure fires. She is working together with Beverly Perkins and the AIC Emergency Preparedness, Response, & Recovery Committee to develop guidelines for firefighters to use on the fire ground during salvage and overhaul operations. They will also prepare a disaster resource sheet for Incident Commanders to hand out to home owners and renters.

The paper conservation lab at the Fine Arts Museums of San Francisco said farewell to **Victoria Binder**, 3rd year intern from the Buffalo training program, who is off to the Museum Fine Arts, Boston, for a Morse fellowship. The lab welcomes

Regional News, continued

Kress Fellow **Nina Quabeck**, on leave from the K20 K21 Museum in Dusseldorf, who will be studying the preservation and conservation issues of three-dimensional works on paper. The lab is also pleased to be hosting **Adam Novak** for his 3rd year internship from the Wintherthur program.

James Bernstein, Conservator of Paintings and Mixed Media, San Francisco, and **Debra Evans**, Head of Paper Conservation, Fine Arts Museums of San Francisco, are recipients of the 2007 American Institute for Conservation Sheldon and Caroline Keck Award, in recognition of a sustained record of excellence in the education and training of conservation professionals. The award was presented at the annual meeting of the AIC held in Richmond, VA (April 2007).

James Bernstein has written the cover article for Golden Artist Colors' newsletter *Just Paint* (Issue 17, September 2007), a special canvas preparation issue. The article "A Remarkable Way to Stretch Canvases (and other Essentials of Canvas Preparation)" will be available for download from the website at www.GoldenPaints.com. A series of Information Sheets will also be available as PDF's from the website, addressing canvas selection, stretcher/strainer supports, stretching technique, the studio environment, etc.

Jim taught three workshops in October: "Mastering Inpainting" (Bernstein and paper conservator Debra Evans, instructors) at the Campbell Center for Historic Preservation, Mt. Carroll, IL, October 1-4; "Mastering Fills" (Bernstein, objects conservator **Meg Craft**, and paper conservator **Margo McFarland**, instructors) for Midwest Conservation Association at the Campbell Center, October 8-9; "Mastering Inpainting" (Bernstein) at the Solomon R. Guggenheim Museum, NY. October 25-30.

Setsuko Kawazu has been hired by the Asian Art Museum as Assistant Conservator, specializing in the treatment of screens and scrolls.

Mark Fenn, Associate Head of Conservation of the Asian Art Museum, spent a month this spring in Bhutan leading a workshop on conserving sculptures for an upcoming exhibit being organized by the Honolulu Academy of Arts. A paper he co-wrote with the Asian Art Museum's former Head of Conservation, Donna Strahan, entitled "A Transfer of Technology: Jade Abrasive Methods Used to Create Inscriptions in

Ancient Chinese Bronzes" has just been published in *Scientific Research on the Sculptural Arts of Asia: Proceedings of the Third Forbes Symposium at the Freer Gallery of Art*.

Matthew Brack successfully completed his internship in paper conservation at the Asian Art Museum and has returned to complete his degree at Northumbria U.

Melissa Buschey is joining the Asian Museum paper lab this fall as a third year intern from the NYU program.

Denise Migdail will be participating in the North American Textile Conservation Conference in DC this November. Denise will be attending the workshop on "Aqueous Cleaning Methods" taught by Richard Wolbers and "X-radiography for Textiles" by Sonia O'Connor.

Regional Reporter:
Beth Szuhay

Membership, continued

McKenzie Lowry, Peter Lundskow, James Martin, Joan Mast-Loughridge, Camille Moore, Cassie Myers, Virginia E. Newell, Laura E. Pate, Carl Patterson, Karen L. Pavelka, Rebecca Pavitt, William LaCroix Phippen, Katrina Posner, Charles S. Rhyne, Anne Russell, Marjorie Shelley, Jude Southward, Tatyana M. Thompson, Rebecca Tinkham, David Turnbull, Josiah Wagener, Stephan Welch, and Donald Zimmerschied.

HEAD OF CONSERVATION SEARCH REOPENED

The Asian Art Museum of San Francisco is seeking an experienced conservator with strong managerial, leadership, and communication skills to supervise and coordinate the staff and operations of the Conservation Laboratory for this world-renowned collection.

Reporting to the Director of Museum Services, the Head of Conservation directs and manages the staff and activities of the Conservation department. As the museum's chief spokesperson on conservation issues, he/she must possess the ability to anticipate the future needs of the institution and to design effective systems for meeting the museum's obligations with regard to the care and preservation of the collection.

The Head of Conservation supervises and performs highly skilled conservation work including examination, research, treatment, documentation, and preparation for exhibition of Asian art objects; determines standards and procedures for the care of Asian artworks within the museum, in exhibitions, and on loan; devises restoration and preservation methods and techniques; consults with curators, scientists, and external conservators; liaises with outside specialists such as painting mounters and framers; and provides information on conservation matters to museum staff, colleagues, and the public.

The ideal candidate will have a significant record of professional accomplishments that may also include publishing and research. He/she will bring energy, vision, and resourcefulness to this critical position. For the full listing and/or to apply online, visit our website: www.asianart.org. EOE

Technical Exchange

A note about the Hot Air Tool made by Steve Prins was planned for this issue when, coincidentally, a thread relating to heating tools developed on the Paintings Specialty Group online list. The following is a compilation of contributions by Steve, Chris Stavroudis, Carolyn Tomkiewicz, and Rob Proctor, which describe alternatives to standard heated spatulas.

Steve's Hot Air Tool, pictured below, is the one I can vouch for. I've had one for about 10 years and have lent it to several conservators who then got their own when they found it indispensable. It's a small unit with controls for air flow and temperature, with a range of 35°- 350°C (95°- 660°F) and a dual speed air pump with a flow valve that permits very low flow for delicate work. It comes with three nozzles 1.5mm, 2mm, and 3mm in diameter. The air hose is an adequate length, but one can opt for the longer size, which makes it more convenient to use, especially for on-site work.



When used with some of the hand tools described below, one can do very delicate manipulations of paint. (OK, so I think in terms of paint. I'm sure it also works for removal of pressure sensitive tapes, texturing thermoplastic materials, etc.) It's not inexpensive, \$1200, but the feeling of doing a better job, easier and faster, is, as they say, priceless. Contact Steve, sprins1102@aol.com for a spec sheet.

The Engelbrecht WZ II control unit regulates a hot spatula, a wax/pigment modeling spatula as well as accommodates a separate unit for temperature control of a Minor welding needle as used in the Heiber "thread-by-thread" tear repair ("Alternatives to Lining 2003" UKIC). Other attachments such as handmade sterling silver tips for the welding needle and a batik wax dispenser are avail-

able. The WZ III of the Engelbrecht series can be additionally outfitted with a radiant heat tool attachment (flip from spatula to radiant); the temperature dial in centigrade regulates heating a small area (about 1/2 - 3/4 inch across) without air flow for cases where displacement with any air flow is an issue. The WZ IV of this series also accommodates a sanding/ drilling tool. Olaf Unsoeld, furniture conservator, is the liaison in the USA for acquiring the tool and other Engelbrecht products; his e-mail link is: unsoeld@earthlink.net. If you'd like to see an image of this tool, go to www.deffner-johann.de/. Go to "Technische Geräte," then to "Heizspachtel und Zubehör" (this European distributor's web-site is in German). Carolyn Tomkiewicz has used this tool for over 15 years without problems or repairs.

Another recommended tool is the Mini Waxer (model 65999) from Almore Dental www.almore.com, for thread-by-thread tear repair and in situations where a very small hot spatula tip is needed. You can call the company and order the tips that best suit your needs. Conveniently these tips also fit the Engelbrecht welding needle attachment. The temperature regulation is very good though not indicated by degree on the dial.

And very similar: the Mini Wax carver available from the Complete Sculptor (www.sculpt.com). It comes with three tips, (others are available) which can be adjusted to suit your needs with emory paper. The tips can be dipped in the stuff made for repairing non-stick pans or low viscosity epoxy like Epotek 301. The former sticks less but the latter will not rub off.

Several kinds of hand tools were mentioned: silicone shaping tools with a variety of shapes, sizes, and hardness (available at many art stores); Teflon tools, in the form of the folder from Hiromi Paper (www.hiromipaper.com, bookbinding section) or a Teflon policeman (www.fishersci.com, Saint-Gobain PTFE Policeman). Either can be carved to suit.

Lastly, some useful general comments: Thermoplastic resins set as they cool. Hot air tools or radiant heat used with a Teflon tool or silicone shaper work bet-

WAAC Publications

Handling Guide for Anthropology Collections

Straightforward text is paired with humorous illustrations in 41 pages of "do's and don'ts" of collection handling. Written by Nancy Odegaard, this manual was designed to be used by researchers, docents, volunteers, visitors, students, staff or others who have not received formal training in the handling of museum artifacts. Paper-bound and printed on acid-free stock.

Price, postpaid:
\$8.85 (\$6.60/copy for orders >10 copies)

Loss Compensation Symposium Postprints

A compilation of the talks comprising the Loss Compensation panel from the 1993 meeting at the Marconi Conference Center, enhanced by a detailed introduction into the history of loss compensation theory written by Patricia Leavengood.

Price, postpaid: \$12.50

Back Issues of WAAC Newsletter

Back numbers of the *Newsletter* are available. Issues **before 1993 cost \$5 per copy**, issues **from 1993 on cost \$10 per copy**. A discount will be given to libraries seeking to obtain back issues to complete a "run" and for purchases of ten copies or more of an issue.

Make your check payable to WAAC. Mail your order to:

Donna Williams

ter than tacking irons for more sensitive manipulation of paint, but it's also important that the tool can be kept in place after the source of heat is removed. Of course these tools can be used following the application of a tacking iron but, this necessitates releasing the pressure while the tools are switched. Best of all, super sensitive paintings can often be consolidated without touching their surfaces by using the hot air tool in combination with a suction platen. One last note: BEVA will stick to Teflon, but not silicone. (The hot air tool is also good for getting caps of paint tubes or small jars unstuck.)

Carolyn Tallent

A Novel Approach to Cleaning II: Extending the Modular Cleaning Program to Solvent Gels and Free Solvents, Part 1

by Chris Stavroudis and Tiarna Doherty

This article has been divided into two parts. This first section deals with principles of solubility and presents the interactive graphical display created to illustrate solubility parameters. The second will discuss the formulation of Carbopol gels and use of the Modular Cleaning Program.

Abstract

The Modular Cleaning Program (MCP) was originally conceived to assist the conservator in the formulation and selection of aqueous cleaning systems. Upon using the system, it became apparent that many of the advantages of the approach could also be applied to both solvent gels and free solvents.

The two overarching principles of the MCP are the use of small amounts of stock solutions that can be mixed to make a large number of test cleaning solutions and the use of physical constants as a basis for all calculations. The conservator decides on a cleaning strategy and uses the program to work through variables to determine the optimal cleaning system. The computer takes care of the bookkeeping issues associated with formulating complex mixtures. The software provides a context showing which parameters may be changed in a cleaning, and the conservator chooses the direction of the testing.

Using small volumes of test solutions offers advantages in cost, ecological impact, and health and safety by minimizing exposure and waste. The speed and ease with which test solutions can be formulated allows many more cleaning options to be tested and evaluated than was previously practical when each test solution had to be made from scratch.

This paper will focus on the design of the solvent and solvent gel capabilities of the program, which will enable a conservator to approach a cleaning using a mixture of free solvents or a set of stock solvent gels that can be mixed together.

The MCP incorporates a new theory for formulating solvent gels. The theory, based on empirical observation, postulates physical-chemical structures for Carbopol-based gels. These structures have been used to calculate the gel formulations. A group of solvent gels has been integrated into the new graphical display of solvent parameters, allowing the conservator to navigate visually through the selection of gel combinations. These features are not fully integrated into the current version of the MCP, but are included in the next version which is being debugged as you read this.

The clearance of Carbopol-based gels will also be addressed within the database. Recommendations for clearance mixtures will be based on the solubility range of the Carbopol/amine present in the gel or gel mixtures and are calculated in Hansen Solubility Space. As yet, this feature is not incorporated into the database, but research is ongoing.

Introduction

The Modular Cleaning Program evolved as an extension of the Gels Research Project at the Getty Conservation Institute. Valerie Dorge, Dusan Stulik, and Richard Wolbers wished to codify, in the form of a "logic tree," the thought process that a conservator would follow to arrive at a successful gel cleaning (Dorge 2004).

Using the logic tree concept as a basis, Chris Stavroudis developed the first version of the MCP, which dealt with aqueous cleaning. It incorporated the use of concentrated stock solutions in set amounts (the "modules") that could be mixed into a wide range of test solutions. The modular system reduced the time necessary to test variables and, more significantly, enabled the conservator to fine tune a cleaning system. After demonstrating the prototype MCP at the Getty Museum, Tiarna Doherty and Stavroudis discussed adapting the methodology to cleaning with solvent gels. The concept was discussed extensively with Richard Wolbers, who also thought there was considerable potential in the idea.

A number of methods were tested for quickly preparing a solvent gel of any polarity from pre-mixed components (Appendix B). It was determined that the most workable approach was to use pre-mixed gelled solvents that could be combined with each other. As with the aqueous system, the conservator would use the stock solvent gels to mix a small amount of almost any solvent gel necessary for testing in a matter of minutes.

In an analogy with inpainting, the set of stock gels can be thought of as the palette, and the individual gels are the different paints. By mixing differing amounts of the paints together, the conservator can match any color within the gamut of the inpainting palette. Similarly, by mixing different amounts of solvent gels in the solvent gel set together, a test gel of any intermediate solvent strength can be formulated. The gel palette differs from paints in one significant way, however. While any paint in the same medium can be mixed with any other, regardless of where they fall on the spectrum, gels need to have compatible polarities. Accommodating this requirement meant widening the solubility range of each stock gel.

The ability to create a gel for a solvent blend depends on the amine used to neutralize the Carbopol and the polarity of the solvent mixture. Typically, Ethomeen C/25 (polyethoxylated cocoamine), Ethomeen C/12 (di ethanol cocoamine), or Armeen 2C (dicocoamine) are the bases used to react with the polyacrylic acid groups that constitute the Carbopol polymer. The amines are also surfactants and the differences in the hydrophilic and hydrophobic character of each determines the polarity of the Carbopol/amine combination. If the polarity of the Carbopol/amine combination is compatible with that of the solvent mixture, the Carbopol polymer, along with its neutralizing amines, can unfurl and impart a three-dimensional framework to hold the solvents in a gel. However if the polarities are incompatible, the gel collapses into a mixture of sticky goo floating in solvent.

In order to extend the solubility range, the idea was developed of using two bases to neutralize the Carbopol in a gel. This is the rationale and genesis of the so-called “dual neutralization gel” which we will discuss later. An additional benefit from widening the solubility range of each gel is that a wider range of solvent mixtures could be used to clear the gel.

To formulate a gel-based test cleaning system it was necessary that solubility theory be incorporated into the MCP. Providing this information would allow the MCP to be used for solvent-based cleaning as well as serve as a framework for discussing the clearance of solvent gels. For the MCP to support solubility theory, physical constants from various sources had to be added to the database. As will be discussed shortly, these physical constants are used to calculate solubility parameters and predict solvent behavior.

Solubility

Solubility theory can best be considered an extension of the fundamental concept: “like dissolves like.” The more a solvent and solute are chemically similar at the molecular level, the better the solvent will dissolve the solute. Of course, solubility is much more complicated than that, which can be seen in the complexity of the numerous solubility theories offered in the literature and the several systems developed to describe the behavior, i.e. solubility parameters, of a solvent. (Feller, Stollow, & Jones 1959; Torraca 1978; Hedley 1980; Burke 1984; Blank & Stavroudis 1989; Phenix 1998). Here, only solubility theory as it relates to the MCP will be discussed.

The single Hildebrand solubility parameter, δ , is an aggregate measure of all intermolecular forces attracting one molecule to another. It is worth mentioning that Hildebrand and Scott proposed an equation (see Appendix A) that gives an estimate of δ based on the boiling point of a solvent. This serves to further emphasize the relationship between the process of evaporation and solubility. It also means that with minimal information, simply knowing a solvent’s boiling point, molecular weight and density, we can estimate its solubility parameter.

However, the Hildebrand system has limitations, as can be seen when considering two very different solvents like n-propanol and dimethylformamide, which have nearly identical Hildebrand solubility parameters and yet have very different characteristics in cleaning works of art. Intermolecular forces arise from more than one sort of attraction and each form of attraction contributes to the total intermolecular force.

Charles Hansen took Hildebrand’s solubility parameter and resolved it into three component parameters, proposing that the total energy holding molecules together was the sum of the energy arising from three component forces: dispersion forces, dipolar forces, and hydrogen bonding forces. Hansen’s three parameters are related to the total (Hildebrand) solubility parameter by the equation:

$$\delta^2 = \delta d^2 + \delta p^2 + \delta h^2$$

The MCP uses Hansen’s solubility theory as the basis for calculations involving solvents and solvent gels. Because the MCP enables the conservator to manipulate solvent mixtures and gels using solubility theory, it is worthwhile to review the component forces in Hansen, Teas, and other similar theories.

Dispersion forces (δd) are the intermolecular forces that attract all molecules to one another. They are comparatively weak and are responsible for hydrocarbons like heptane being liquid and larger molecules, like waxes, being solids. Also called London or van der Waals forces, they are explained by quantum mechanics. When molecules are in close proximity, the electron cloud of one molecule induces a distortion in the adjacent molecule’s electron cloud. The distortion causes a net attractive force despite the fact that the electron clouds should really repel one another. Van der Waals forces are related to the surface area of a molecule and function only at close distances. So greater structural similarity between solvent and solute allows molecules to pack closer together and have more area in common, thereby increasing the van der Waals attractive force.

Dipolar forces (δp) are often, and incorrectly, referred to as polar forces, as the actual phenomenon of polarity results from a combination of forces. Adding to the confusion, because the subscript ‘d’ is already taken for dispersion forces, they are noted by the subscript ‘p’. Dipolar forces arise from electrostatic attractions between molecules. They arise from permanent dipoles created by the molecular structure, where partial positive charge is separated in space from partial negative charge in the same molecule. Partial positive charges on one molecule are attracted to the partial negative charges on an adjacent molecule. Dipoles can also be induced into molecules that don’t normally possess a permanent dipole resulting in a net attractive force between the molecules. Dipolar forces are the predominant intermolecular force in ketones.

Hydrogen bonding interactions (δh) are the strongest of the intermolecular forces. Hydrogen bonds are temporary bonds that form between hydrogen atoms attached to a strongly electronegative atom (O, N, F) in one molecule and another strongly electronegative atom in an adjacent molecule (or, in larger molecules, in the same molecule). This temporary bond forms because the first strongly electronegative atom pulls the electron cloud from around the hydrogen molecule, leaving a somewhat exposed proton nucleus. If a strongly electronegative atom in an adjacent molecule likewise has pulled the electron clouds from atoms within its molecule, it will have acquired a partial negative charge, and will be attracted to the partial positive charge of the hydrogen proton. Hydrogen bonding is predominant in alcohols.

Unfortunately, hydrogen bonds behave more like an acid-base reaction than a simple attractive force, and this is a weakness of the Hansen solubility theory. However, in most cases, the Hansen partial solubility parameters work fairly well, and they are used in the solubility calculations in the MCP.

J.P. Teas took Hansen’s three partial solubility parameters, normalized them, and then plotted them on a triangular graph. The Teas diagram offers a graphical view of solvent strength that is well known to conservators. There are many excellent references in the conservation literature that discuss the use of the Teas diagram (Burke 1984; Torraca 1978; Hedley 1980), four computer programs that make calculations based on the Teas parameters (Henry 1989; Bertolli and Cremonesi; Ormsby; GELodata) as well as treatments of solubility theory much more comprehensive than that presented here (Phenix 1998; Phenix and Sutherland 2001; Phenix 2002). Unfortunately, the Teas chart has other problems (Phenix 1998; Blank and Stavroudis 1989) which compound the limitations of Hansen partial solubility parameters, hence the use of the Hansen parameters for calculations in the MCP.

There are buttons in the MCP to display the solvent positions in Hansen 3 dimensional space or on a 2 dimensional Teas diagram. (As of this writing the 2 dimensional plotting does not yet work.) The feature only works on the Macintosh platform and uses the program “Grapher.app” which is included with current Mac operating system software. The process is a bit cumbersome, but allows visualization of Hansen space and the solvent mixture being considered (figure 1).

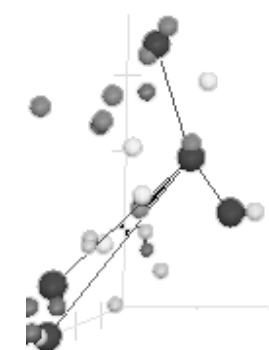
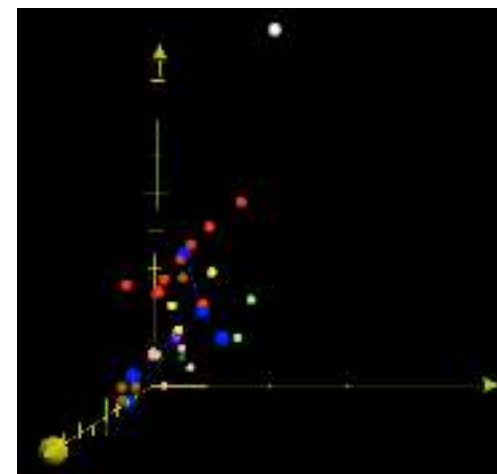

Figure 1
A view of Hansen space as visualized by Grapher.app.

The enlarged detail, with the background converted to white, shows the lines connecting the four component solvents to the mixture of the four in the center.

Various tabulated Hildebrand and Hansen solubility parameters have been entered into the MCP. Where sufficient raw data is available, the MCP also calculates the Hildebrand and Hansen solubility parameters via a number of calculations as explained in Appendix 1. The MCP preferentially uses the published, tabulated values from: “Hansen and Beerbower’s 1971 Parameters for Liquids at 25°C” as published in Barton, Table 11 (1991).

There is one more complication to mention: the formation of azeotropes. An azeotrope is a particular mixture of solvents that has a boiling point minimum (or maximum) lower (or greater) than the starting components. As conservators, we are only interested in azeotropes that show a minimum boiling point. Hildebrand solubility parameter can be calculated from a solvent’s boiling point. The boiling point of an azeotrope is lower than either of the component solvents. This means that an azeotropic mixture of solvents will have an anomalous solubility parameter. This anomaly is not calculated for in the MCP. However, the MCP does alert the conservator of any binary or ternary azeotropes that might exist for the mixture under consideration.

Aging and Solubility

So, after all of the theoretical discussion, one is back to “like dissolves like,” with the proviso that “like” be evaluated on a decidedly chemical basis. Of the many “cleaning” scenarios in conservation, probably the most common is dissolving one material from another where the second material was deposited in a “mild” solvent but the coating, adhesive, or paint has changed with time and no longer dissolves in the solvent in which it was deposited. The change in solubility of the second material upon ageing is typically caused by any of four possible chemical changes. An organic material can oxidize, form double, often conjugated double, bonds (i.e., yellow), increase in molecular weight by cross-linking, or reduce its molecular weight by chain scission. (Only the first two are of significant interest in this discussion.)

In a very simplistic way, oxidation of paint or varnish can be considered as the addition of alcohol or ketone groups (or both when forming a carboxylic acid) to the material. To re-dissolve oxidized material, the polarity of the solvent has to increase by moving towards either higher dipolar strength solvents or higher hydrogen bonding solvents (or both). Ultimately, oxidation can require such high polarity solvents that an aqueous cleaning system may be considered.

Similarly, yellowing can be thought of as the addition of unsaturation (double bonds) to the structure. It might be too broad a generalization of “like dissolves like,” but it is a convenient oversimplification to try to re-dissolve yellowed material by increasing the proportions of double bonds by increasing the aromatic character of the solvent.

Applying Solubility Theory

It was necessary to make some adaptations to the original MCP so that it would work with solvents, both free solvents

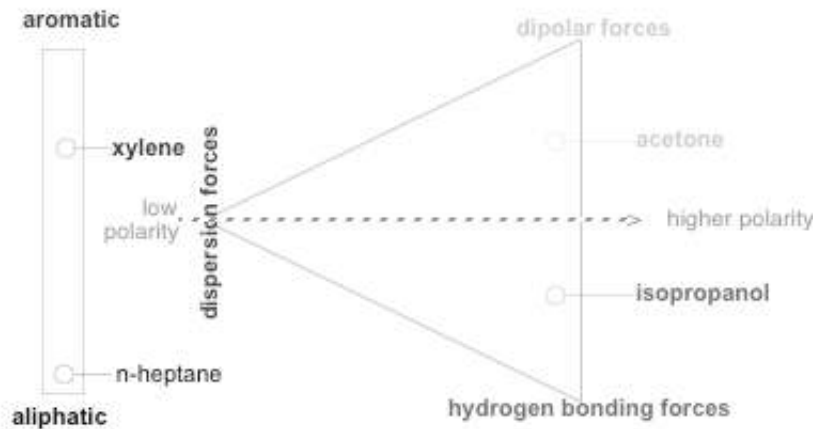

To use the diagram – which, please remember, is designed to be a tool and not a new theory – one selects a solvent to represent each solvent class: aromatic, aliphatic, dipolar, and hydrogen bonding. Then by changing the proportions of these solvents the database can calculate the polarity and aromaticity of the solvent mixture. In the MCP, the polarity triangle and A/A bar are interactive. As the composition of the test solvent is changed, the position of the dots (one in the polarity triangle and one in the A/A bar) move, providing a visual reference for the conservator.

Figure 2. The graphical display which illustrates solubility space in the MCP. There are two separate but related elements in the diagram: the polarity triangle and the aromatic/aliphatic (A/A) bar.

and gels. Adding data on solvents to the MCP was easy, although tracking down many of the physical constants required referring to a number of different reference sources (Lide 2002; Weast 1972; Budavari 1989; Gmehling et al. 2004). Adding the algorithms for working with mixtures of solvents in Hansen space, calculating Teas values and NFPA hazard ratings was more of a challenge. The most difficult task was to come up with an interface that made sense of the numbers generated by the computer and an intuitive means for the conservator to interact with the model.

As always when three variables are interacting, the best way to illustrate it is in three dimensions. Unfortunately, practically speaking this is awkward to display and interpret.

Hence, the most significant change in the MCP is an interactive, graphical display of solvent parameters (figure 2) for working with both solvent mixtures and solvent gels. This display is based on Hansen solubility parameters and a new parameter, which we have called the aromatic/aliphatic index. This diagram does not represent a new solubility theory but is a visualization tool for the conservator. You will notice that a few familiar solvents have been indicated on the diagram.

Examining the polarity triangle one sees that the three apexes are labeled dispersion forces, dipolar forces, and hydrogen bonding forces. While this may superficially resemble the Teas Diagram, it is not the same at all. The horizontal line from the left apex represents increasing polarity (in the broader sense of the term) and is the source of the triangle's name. The increased polarity results from increasing hydrogen bonding forces, dipolar forces, or both. This trend can be thought of corresponding to oxidation in our simple model of the aging of organic materials.

The previous discussion of aging posits that yellowing is attributable to the formation of double bond and that double

bonds require aromatic content to solubilize them. From the perspective of the conservator, solubility theory is not entirely satisfying in reflecting the subtlety of differences between aromatic and aliphatic solvents. To demonstrate the influence of the y axis dispersion forces, the vertical axis of the diagram has been detached, as it were, and laid flat.

When the proportions of a solution change, and its inter- and intra-molecular forces change, two dots appear on the new version of the diagram. One, on the triangle, demonstrates its character relative to dipole forces and hydrogen bonding (solution polarity), while dispersion forces are demonstrated on the aromatic/aliphatic bar. (The A/A bar is not an actual measure of the dispersion forces, but reflects the ratio of aromatic to aliphatic in the solution. See Appendix B for a discussion of how the aromatic/aliphatic index is determined.) When the proportions change again, these move simultaneously to show the new set of behavior characteristics. (figure 3)

The next installment of this article will present our ad-hoc theory of Cabopol based solvent gel formation and will discuss how this empirically derived model is used in the MCP to assist with solvent gel formulation. We will then discuss in further detail how an understanding of solubility theory can suggest approaches to cleaning with solvents and solvent gels and how the MCP can assist with formulating cleaning systems. We will also consider how future research will allow us to determine the solvent mixtures that will most effectively clear a specific solvent gel formulation by using Hansen solubility space calculations to determine how "good" a solvent or solvent mixture will be at keeping a given gel in a happy place, from a solubility perspective.

The MCP is available as freeware. Conservators must register before the software will work in an effort to keep non-professionals from thinking that a computer program can substitute for a professional conservator.

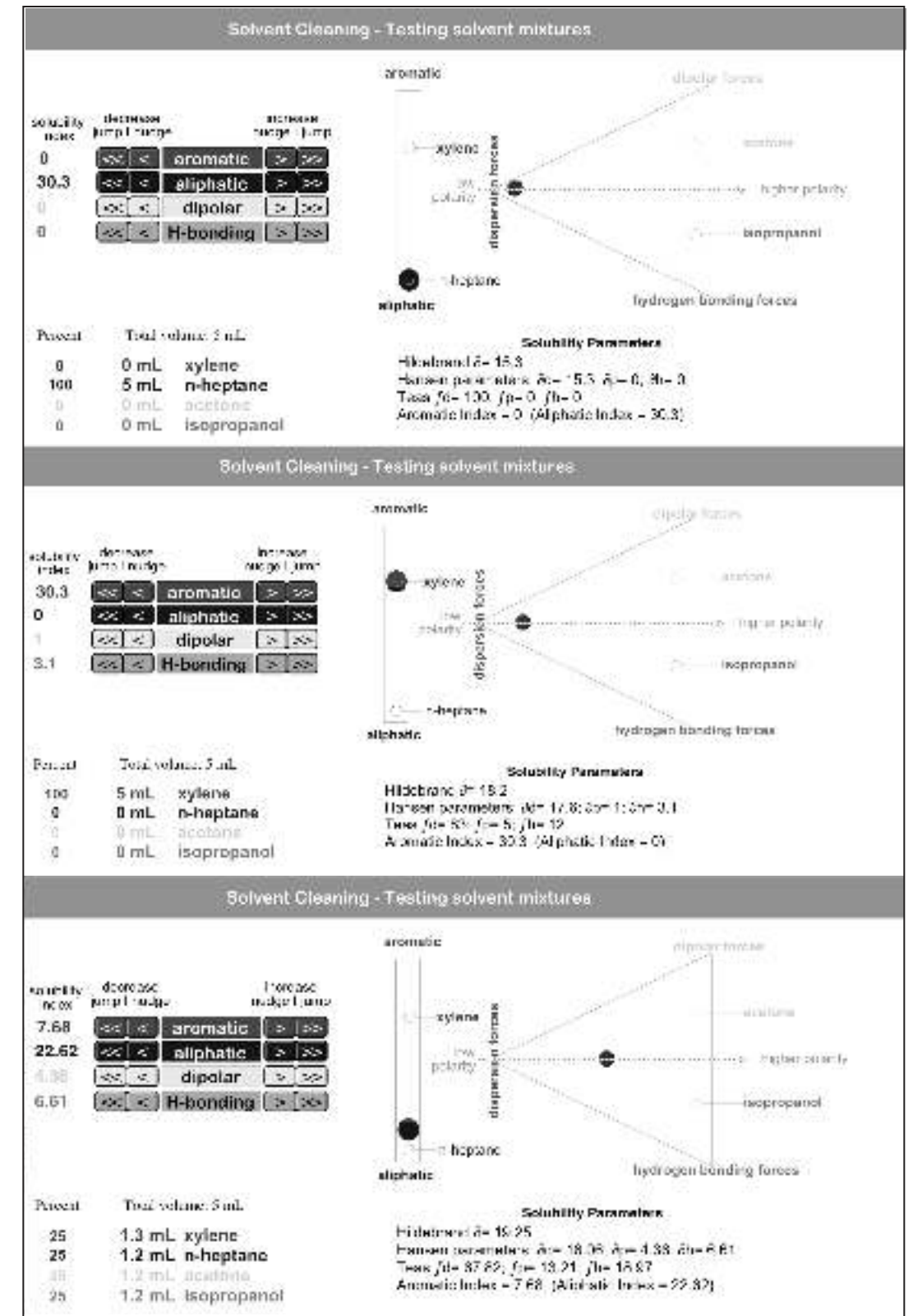

Figure 3. Three views of the solvent cleaning screen in the MCP, showing n-heptane alone, xylene alone, and a 1:1:1:1 mixture of n-heptane : xylene : isopropanol : acetone

Slightly Technical Appendices:

Appendix A – Solubility Parameter Calculations

To calculate the Hildebrand solubility parameter of a solvent, one looks up values for the enthalpy of vaporization, its molecular weight and density. The MCP calculates the Hildebrand solubility parameter from the following equation:

$$\delta = [(\Delta H - RT)/V_m]^{1/2}$$

V_m , the molar volume, is simply the molecular weight of the solvent divided by its density, R is the gas constant, and T is the temperature in degrees Kelvin. However, ΔH , the enthalpy of vaporization is a complicated quantity to measure experimentally. Hildebrand and Scott proposed an empirical equation that relates the enthalpy of evaporation to the boiling point of the solvent:

$$\Delta H \approx -12340 + 99.2(T_b) + 0.084(T_b)^2$$

where T_b is the boiling point of the solvent in degrees Kelvin.

In earlier versions of Hansen's work, he proposed equations to determine the dipolar and hydrogen bonding parameters based on measurable constants. Hansen used the Böttcher equation to generate estimates for the dipolar solubility parameter via:

$$\delta_p = 2.0455 * [(12108 / V_m^2) * (\epsilon - 1) / (2\epsilon + n_D^2) * (n_D^2 + 2) * \mu^2]^{1/2}$$

where ϵ is the dielectric constant, n_D is the index of refraction, and μ is the dipole moment of the solvent (Hansen 1967, p. 25).

Likewise, Hansen proposed that the hydrogen bonding partial solubility parameter could be calculated for alcohols by dividing the energy of a hydrogen bond (5000 cal., determined from the IR spectra for a typical H---OH hydrogen bond) by the molar volume:

$$\delta_h = 2.0455 * [5000 * A / V_m]^{1/2}$$

where A is the total number of alcohol groups in the molecule (Hansen 1967, p. 24). In both equations, the factor 2.0455 converts from older cgs units of [cal/cm³]^{1/2} to the S.I. units of [MPa]^{1/2} where MPa are megaPascals.

The MCP calculates the Hildebrand solubility parameter from both measured ΔH values and the boiling points of the solvents if there are sufficient physical constants in the database. If additional constants are available, it will also calculate the dipolar and hydrogen bond Hansen param-

eters from the above equations and calculate the dispersion parameter by difference. Many of the constants have been located in reference sources, but not all information is available for all solvents. Mixed solvents, such as mineral spirits, etc., of course don't possess these values as we are not privy to the chemical composition of these solvent mixtures but the manufacturer often provides the Hildebrand solubility parameter.

Appendix B – The Aromatic/Aliphatic Index

One way to estimate the difference in energy between aromatic and aliphatic compounds is to compare benzene and cyclohexane. Examining the pattern of the heat of hydrogenation between cyclohexane, cyclohexene, and cyclohexadiene and extrapolating that pattern to a non-existent, non-aromatic, cyclohexatriene, and then comparing that value to benzene, one finds a resonance energy of 36 kcal from the formation of an aromatic ring. This value is also consistent with the heat of combustion (Morrison and Boyd 1973, p. 323).

Paralleling the way Hansen originally defined the hydrogen bonding partial solubility parameter (above), we have proposed an aromatic/aliphatic index as the resonance energy of an aromatic ring divided by 6 (for the six carbons in both molecules) times the number of aromatic atoms (#A) in the molecule and then multiplied by the number of aromatic atoms divided by the total number of carbons (#C).

$$\text{Aromatic index} = 2.0455 * [36,000 * (\#A/6) * (\#A/\#C) / V_m]^{1/2}$$

While this definition is arbitrary, a list of aromatic solvents and their aromatic/aliphatic indices feels right in terms of practical solvent power. Table 1 shows the aromatic/aliphatic index for a number of familiar solvents along with their aniline point, kauri-butanol number, Reichardt's E_T^N values, and Freed's Spectral Polarity Index, P_s .

There are certainly other ways of formulating a ranking of aromatic strength, and from the perspective of the MCP, any could be used. (And if a more sensible schema is proposed, it could be incorporated into the MCP.) Unfortunately, the Percent Aromatic value that is often found in solvent specifications is quite misleading. ASTM defines the value of percent aromatic as the volume percent of a constituent component that contains an aromatic structure. So, by that definition, xylene, toluene, and benzene are all 100% aromatic.

Table 1 The Aromatic/aliphatic index compared with other polarity measurements.

Solvent	Aromatic/aliphatic index	% of benzene	Aniline point	% of heptane	Kauri butanol #	% of benzene	E_T^N	% of benzene	P_s	% of benzene
Benzene	41.1	100%	22°F	14%	112	100%	0.111	100%	6.95	100%
Toluene	34.9	85%	47°F	30%	105	94%	0.099	89%	6.58	95%
Xylene	30.3	74%	48°F	31%	98	88%	0.074	67%	6.27	90%
Diethyl benzene	24.1	59%								
heptane	0	0%	154°F	100%	30	27%	0.012	11%	2.77	40%

Acknowledgements

The authors would like to thank Alan Phenix for his discerning comments and suggestions and Carolyn Tallent for an extraordinary amount of editorial collaboration.

References

Barton, A.F.M. 1983. *CRC Handbook of Solubility Parameters and other Cohesion Parameters*. Boca Raton: CRC Press, LLC.

Barton, A.F.M. 1991. *CRC Handbook of Solubility Parameters and other Cohesion Parameters*, 2nd Edition. Boca Raton: CRC Press, LLC.

Bertolli, I. and Cremonesi, P. 1999. Un approccio più scientifico alla pulitura dei dipinti. Triansol ®: il Triangolo delle solubilità, un software per il restauro. *Progetto Restauro*, 10: 42–45.

Blank, S. and Stavroudis, C. 1989. Solvents and Sensibility, Parts 1-3. *WAAC Newsletter*, 11(2): 2-10.

Budavari, S. ed. 1989. *The Merck Index: An Encyclopedia of Chemicals, Drugs, and Biologicals*, 12th Edition. Whitehouse Station: Merck & Co.

Burke, J. 1984. Solubility Parameters: Theory and Application. *The Book and Paper Group Annual*, 3: 13-58.

Dorge, V. ed. 2004. *Solvent Gels for the Cleaning of Works of Art*. Los Angeles: Getty Publications.

Feller, R., Stolow, N., and Jones, E. 1959. *On Picture Varnishes and Their Solvents*. Washington: National Gallery of Art.

Freed, B.K., Biesecker, J., and Middleton, W.J. Spectral Polarity Index: A New Method for Determining the Relative Polarity of Solvents. *Journal of Fluorine Chemistry*, 48: 63-75.

GELodata website. SOLVATOR® software. URL: www.gelodata.de.

Gmehling, J., Menke, J., Krafczyk, J., and Fischer, K. 2004. *Azeotropic Data, Parts 1-3*, 2nd Edition. Weinheim: Wiley-VCH Verlag GmbH.

Hansen, Charles M. 1967. *The Three Dimensional Solubility Parameter and Solvent Diffusion Coefficient: Their Importance in Surface Coating Formulation*. Copenhagen: Danish Technical Press.

Hansen, Charles M. 2000. *Hansen Solubility Parameters. A User's Handbook*. Boca Raton: CRC Press, LLC.

Hedley, G. 1980. Solubility Parameters and Varnish Removal: A Survey. *The Conservator*, 4:12-18.

Henry, W. 1995. Application Development for the Conservation Laboratory. In: *Advances in Preservation and Access, Vol. II*, ed. B. Buckner Higginbotham, Medford, Learned Information, Inc.: 156–179.

Henry, W. 1989. TeasTime. (Computer software, obsolete but available from <http://palimpsest.stanford.edu/packages/>).

Lide, D. R., ed. 2002. *CRC Handbook of Chemistry and Physics*, 83rd Edition Boca Raton. CRC Press, LLC.

McGlinchy, C. 2002. Boundaries of the Teas Solubility Concept. *WAAC Newsletter*, 24(2): 17-19.

Morrison, R.T. and Boyd, R.N. 1973. *Organic Chemistry, 3rd Edition*. Boston: Allyn and Bacon, Inc.

Nelson, R.C., Hemwall, R.W., and Edwards, G.D. 1970. Treatment of Hydrogen Bonding in Predicting Miscibility. *Journal of Paint Technology*, 42(550):636-643.

Ormsby, M. 2001. Solvent Solver Program. *AIC News* 26(5):6.

Ormsby, M. 2004. Solvent Solver: A Calculator for Working with Teas Fractional Solubility Parameters. http://palimpsest.stanford.edu/packages/solvent_solver.html.

Phenix, A. 1998. Solubility Parameters and the Cleaning of Paintings: an Update and Review. *Zeitschrift für Kunsttechnologie und Konservierung*, 12(2):387-408.

Phenix, A. and Sutherland, K. 2001. The Cleaning of Paintings: Effects of Organic Solvents on Oil Paint Films. *Reviews in Conservation*, 2:47-60.

Phenix, A. 2002. The Swelling of Artists' Paints by Organic Solvents and the Cleaning of Paintings: Recent Perspectives, Future Directions. *2002 AIC Paintings Specialty Group Postprints*, Miami FL June 6-11: 71-86.

Phenix, A. 2002. The Swelling of Artists' Paints in Organic Solvents. Part 1: A Simple Method for Measuring the Inplane Swelling of Unsupported Paint Films. *Journal of the American Institute for Conservation*, 41:43-60.

Phenix, A. 2002. The Swelling of Artists' Paints in Organic Solvents. Part 2: Comparative Swelling Powers of Selected Organic Solvents and Solvent Mixtures. *Journal of the American Institute for Conservation*, 41:61-90.

Teas, J.P. 1968. Graphic Analysis of Resin Solubilities. *Journal of Paint Technology*, 40(516):19-25.

Torraca, G. 1978. *Solubility and Solvents for Conservation Problems*. Rome: ICCROM.

Weast, R.C., ed. 1972. *CRC Handbook of Chemistry and Physics*, 53rd Edition. Cleveland: The Chemical Rubber Co.

Wolbers, R. 1988. *Notes for Workshop on New Methods in the Cleaning of Paintings*. Unpublished manuscript. The Getty Conservation Institute, Los Angeles.

Wolbers, R. 2002. *Cleaning Painted Surfaces: Aqueous Methods*. London: Archetype Publications.

Protecting Collections in the J. Paul Getty Museum from Earthquake Damage

In 1983 the Getty Museum in Los Angeles, California began efforts to reduce the damaging effects of earthquakes to its collections by:

Characterizing the overall geology and seismic history of the museum site and describing a worst-case seismic event that might occur within a reasonable time frame and at a reasonable risk level,

Determining the overall response of the museum building to such an event,

Determining how the contents of the building (collections, display furniture, and fixtures) would respond to the earthquake motions and forces, and

Developing seismic mitigation approaches to protect the collections.

The four basic methods which were developed to mitigate damage will be discussed in the latter part of this article. They are:

Lowering the object's or object assembly's center of gravity by adding weight to the lower parts of the display assembly,

Lowering the center of gravity by adjusting the proportions of the display assembly (adjusting the base to height ratio for more stability),

Restraining objects by firmly securing them to the floor, pedestals, shelves, wall, and/or supporting mounts. This approach requires that the object have sufficiently high inherent strength and rigidity (or have them enhanced by a supporting mount) to withstand the earthquake forces, and

Allowing sliding of the display furniture by the use of base isolation mechanisms.

Defining the seismic threat

The mitigation approaches discussed above, particularly base isolation, could only be undertaken when a thorough understanding of how earthquakes affect structures and contents was achieved. The assistance of experienced seismic engineers and seismologists was necessary to establish the characteristics of the worst case scenario earthquake predicted for the area and specific site where the collection is housed.

The duration, strength, frequency content, and potential for displacement of the simulated earthquake, as well as the response of the building (indeed the specific areas of the building) where the collections are housed, give direction to any efforts in developing mitigation approaches. For example, it is more important to know the peak acceleration, velocity, and predominant period of an earthquake (and the building and object response), than it is to know the expected Richter scale magnitude since the former can provide measurable design criteria. Insufficient design can be useless and even make things worse during an earthquake.

In 1984 the Getty Museum commissioned Lindvall, Richter, and Associates to prepare a geologic and seismologic study of the museum site and a geotechnical and structural response study of the Villa museum building,¹ later updated by the URS corporation.² The museum defined an event with an 80% probability of being exceeded in 50-years (reoccurrence estimated to be every 225 years) as an acceptable risk level.

The study identified two events that would have the most impact upon the museum: an 8.3 Richter scale earthquake on the San Andreas fault, some 67.5 km away from the museum (resulting in a horizontal ground acceleration of 0.2 g at the museum site) and a 6.5 Richter scale earthquake on the Malibu Coast/ Santa Monica fault system at a distance of 1.6 km (potentially producing a maximum 0.7g horizontal ground acceleration at the museum site).

Determining the behavior of objects

The conclusions of the Lindvall report provided dynamic data for use in analyzing the behavior of art objects housed at the museum, such as the 1990 research by Aghabian, Masri, and Nigbor³ that attempted to predict the seismic response of art works by modeling generic categories that represented groups of similar objects.

From these studies basic criteria for stability have evolved. For example, the response of a rigid object to earthquake induced forces and motion can be sliding or, if the friction between the object and the supporting plain is high enough, rocking and eventual overturning. Rocking and overturning are based both on the nature of the earthquake and the object's (or object assembly's) geometry and mass distribution. Figure 1 shows an overturning chart based on data from the Getty site design earthquake.

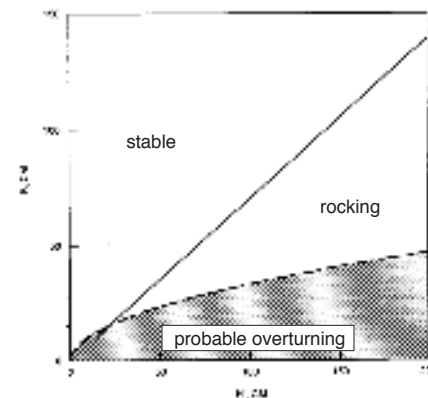

Figure 1. Rocking stability chart for the Getty Villa. Primary horizontal component peak acceleration is 687 cm/sec² (0.7g) and peak velocity is 33.9 cm/sec. Reprinted from M.S. Aghabian, et al, *Evaluation of Seismic Mitigation Measures for Art Objects*, p. 38.

Rocking and sliding will occur when the ratio of the maximum horizontal acceleration is greater than B/H aspect ratio: $a_{max} > B/H$. Overturning will occur when the relationship of the aspect ratio to velocity of the earthquake is as follows: $V_o > 10 B / \sqrt{H}$. Whether rocking, sliding, or overturning occurs also depends upon the location of the center of gravity as in figure 2.

by McKenzie Lowry, BJ Farrar, David Armendariz, and Jerry Podany

This paper was first presented at the international conference Istanbul 2007: Earthquake Protection of Museums, hosted by the Pera Museum.

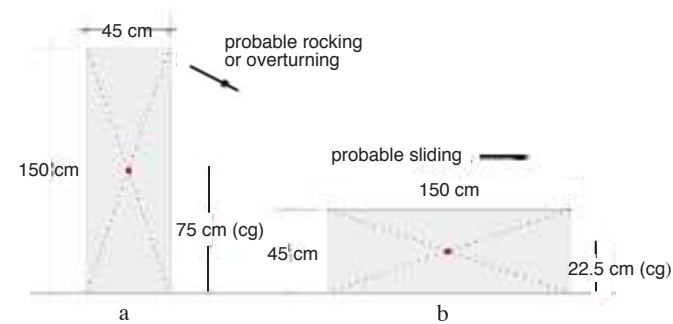

Figure 2. An overturning or sliding response is directly related to the aspect ratio. In a the object will most probably rock and/or overturn, while in b, with a lower center of gravity and a more favorable aspect ratio, the response will be sliding (assuming a sufficiently low coefficient of friction between the object and the support plane).

Altering the aspect ratio and/or adding weight to the lower sections of the assembly are two ways the center of gravity can be lowered for greater stability. Before this is attempted however, calculating the actual location of the center of gravity of any object or assembly is essential.

Determining the center of gravity

The term center of gravity (cg) describes a theoretical point within the mass of an object or object assembly where all earthquake forces are focused. The lower the center of gravity is the more stable and resistant to rocking and overturning the object or assembly is. One of the simplest meth-

ods of determining the cg is to measure the maximum depth, width, and height of the object and then translate those dimensions into a geometric volume that closely resembles the object's shape, assuming an even weight distribution throughout the entire volume of the object. The center of gravity will be roughly the same as the calculated center of the geometric volume, see figure 3.

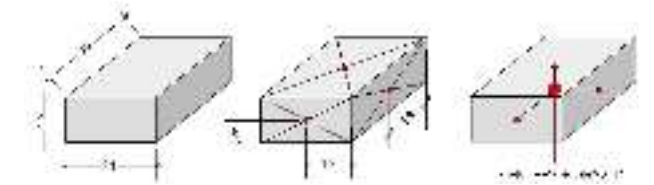

Figure 3. A simplified method of determining center of gravity locates the center of a geometric volume. This assumes however that the simplified geometric model accurately reflects the mass of the object and that the density of material is consistent throughout.

Determining the Equivalent Block

When an object is composed of segments with differing dimensions or densities, each segment can be translated into a geometric shape and the equivalent block determined (figure 4). This method can be advantageous when an object is complex in shape; is made of a variety of segments; has an eccentric distribution of mass; or is part of an assembly (such as a sculpture and pedestal combination). If the separate components cannot be weighed, calculations can be made based on standard material property references.

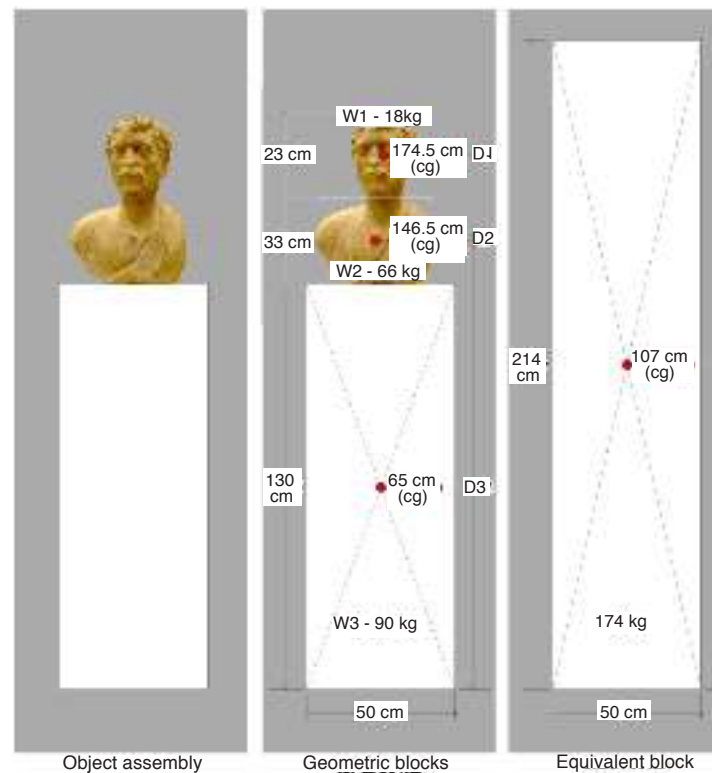

Figure 4. Determining the equivalent block of an object assembly, in this case a sculpture and a pedestal combination.

$$\frac{(D1 \times W1) + (D2 \times W2) + (D3 \times W3)}{W1 + W2 + W3}$$

D= Distance from the ground to each section's Cg
W= Each section's weight
Hcg = Height of the equivalent block

If: D1 = 174.5cm and W1 = 18 kg,
D2 = 146.5cm and W2 = 66 kg,
D3 = 65cm and W3 = 90 kg.

then:
 $\frac{(174.5 \times 18) + (146.5 \times 66) + (65 \times 90)}{18 + 66 + 90}$ or: $\frac{18660}{174} = 107.2$

Thus the equivalent block has a center of gravity at 107 cm and 2Hcg formula gives us an equivalent block height of 214 cm.

Using the effective aspect ratio formula, $.5B/H_{cg}$, (25/107), we find that the unit has an effective aspect ratio of 0.23.

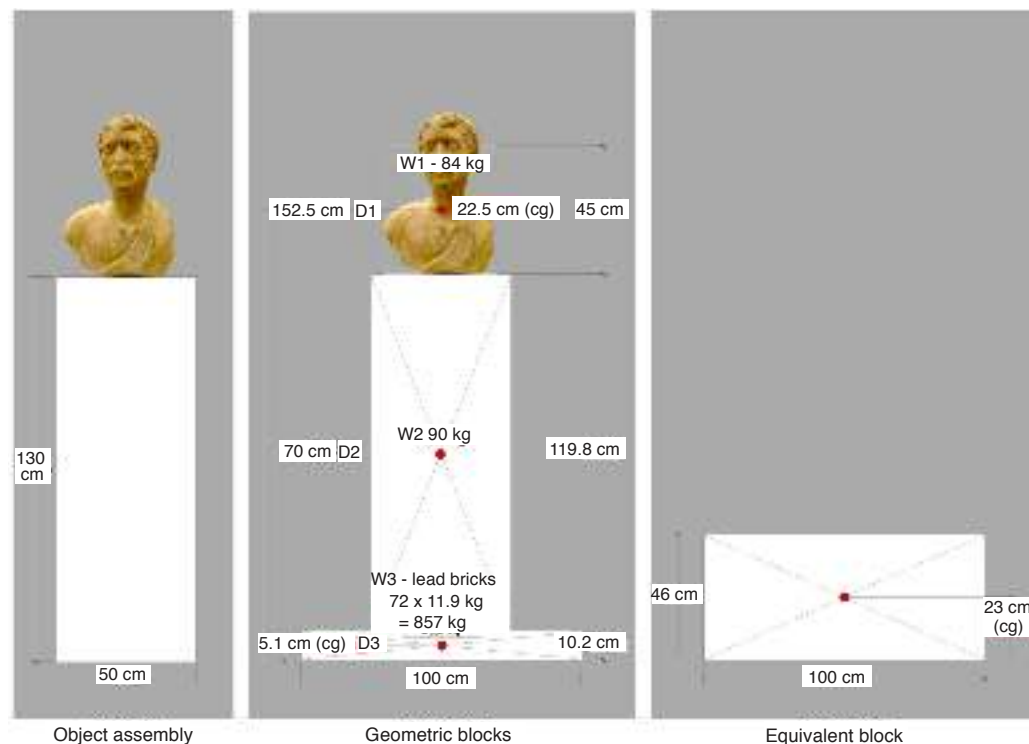

Figure 5. Looking at the system's new equivalent block, the cg has been lowered to 23 cm by adding 857 kg and increasing the base by 50 cm. NOTE: The center of gravity must be calculated for the added weight mass, in this case lead. Stacking the weight too high will cause the mass to become unstable.

Lowering the center of gravity by adjusting the proportions of the exhibition furniture
If a resultant center of gravity is found to be too high, the cg can be lowered using a number of approaches. For example, the object can be fastened to the floor. Although this provides the most stability of any option, the object must be sufficiently sound to withstand the earthquake forces transmitted to it. The base or pedestal can be made wider or weighted for greater stability. An appropriately sized base plate or an enlarged base at the bottom of the pedestal are also options as shown in figure 5.

Calculating the effective aspect ratio of the assembly in figure 5 reveals a more favorable effective aspect ratio.

It should be noted that if the height of the plinth/added weight component in figure 5 increases beyond the height of the added weight mass (perhaps due to aesthetic design concerns), the plinth and weight mass should be treated as two separate components in the calculations for equivalent block.

Seismic mount making

The previous discussion assumes that the object is sufficiently robust and rigid to withstand any transmitted earthquake force. Since this is rarely the case, additional strength can be provided by introducing supportive mounts that cradle and restrain the object on display.

Effective mount making requires familiarity with diverse materials, including a wide range of metals, woods, plastics, synthetic composites, and fabrics. Mounts should always be

made of stable materials that are non-abrasive, non-corrosive, stable, non-staining, and free of corrosive vapors. When designing a mount the contact point between a mount and an object should be sufficiently large; fit as intimately as possible; and always be non-abrasive. Small contact points result in higher point-load forces, thus a larger contact area is used to distribute the forces and provide a more secure mount-to-object connection.

Mounts should be designed in such a manner that the object and mount can be quickly separated if desired. Adhering a mount to an object should be avoided if possible.

A safety factor of three is generally considered good practice when choosing the strength of the material from which a mount is made. Dynamic forces due to earthquake motions can increase the total load on a mount by several magnitudes. This might translate into using a hook with an ultimate strength of 68 kg to hang an object weighing 22.68 kg.

Stationary/supportive mounts

While stationary/supportive mounts restrain objects and minimize dynamic loads that might be caused by the impact forces of rocking or falling, it is very important that the mounted object is sufficiently robust in nature to withstand a considerable proportion of the seismic load transferred through the building structure. Protection is dependent upon the object being firmly held to the mount at suitable points and over a suitably large area, and the mount must be securely fastened to the exhibition furniture, the wall, or the floor. The assembly must be rigid and respond as a single unit. Although a number of smaller objects on display at the

Getty Museum are restrained using very simple anchoring methods (such as wax or synthetic monofilament), more substantial mounts are the more common approach. These include the following:

Interfaces

Objects which do not sit in a stable and level position, have uneven contact with the supporting plane (floor, pedestal top, or case deck), or have the majority of their weight concentrated on small points (point loaded), require a custom interface to distribute the load evenly over the bottom surface or over the surface on which the object rests (figure 6). Such interfaces are made of high compression strength materials, such as filled epoxies. Prior to casting an interface, the underside of the object's base should be inspected for under-cuts or cavities to avoid any physical "locking" of the interface to the object itself.

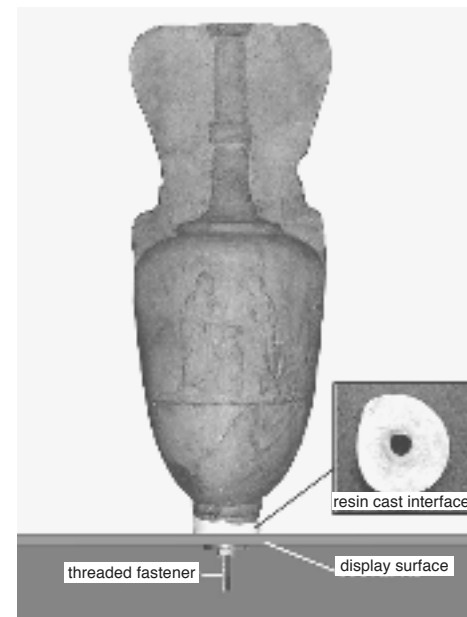

Figure 6. An example of an interface supporting the broken bottom edge of an object.

To cast an interface a modest amount of thixotropic epoxy is placed on a non-stick surface and covered with a sufficiently thick barrier of thin plastic film (such as the type used in the food service industry). The object is then lowered onto the plastic film and allowed to settle until the desired orientation is achieved and the excess epoxy is displaced.

At this point the object should be secured so that it does not shift while the epoxy is curing. Care should be taken to assure that none of the epoxy has come into direct contact with the object. Once the epoxy is fully cured the object is lifted away, the plastic wrap removed and the interface trimmed to the desired shape. In most cases the interface will be secured to the display deck rather than to the object.

Clips

Clips are relatively small point-of-contact mounts that restrain an object's movement but normally do not provide any support (figure 7).

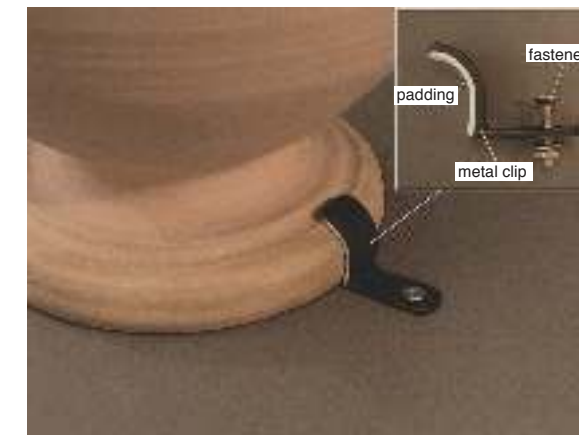

Figure 7. A typical clip assembly.

A three-point restraint is recommended when using clips to secure objects with round or oval bases. In these cases the clips are spaced as close to 120 degrees apart from each other as possible (figure 8).



Figure 8. Object secured with clips and interface.

For square or rectangular bases clips on all four sides or at each corner are required. The edges of each clip should be slightly rounded and an appropriate felt or padding should be applied to the interior faces to protect the object's surface.

For objects that are mounted to the wall the clips may also support the object vertically (along the lower edge). In the instance of freestanding objects clips are normally applied to the object's base or lower edge. Caution must be exercised however since considerable stress will be concentrated at the point where the object is anchored during an earthquake. The taller the object is, and the higher the location of the center of gravity, the greater the forces will be at the anchor (clip) points. Stress failure at the area of load concentration (point loads caused by the clips) or at the area of material weakness is highly likely. Objects must sit flat, and if they do not, casting an appropriate interface is necessary.

Contour mounts

A contour mount is a supportive restraint that closely follows the exterior form of the object, providing complete contact along the object's profile. A measurement of the object's profile is attained using a profilometer, plastic contour gauge, or by cutting out and piecing together sections of stiff paper or cardboard as shown in Figure 9.

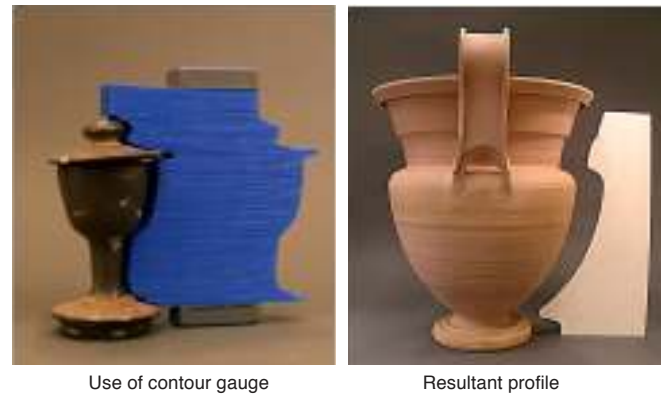

Figure 9. Using a plastic profile gauge and a profile cut in cardboard.

In most cases four basic materials are used to fabricate contour mounts; steel (including stainless steel), brass, aluminum, and acrylic (figure 10).



Figure 10. Four different styles of contour mount using different materials.

The material must have the strength and stiffness to support the object as well as withstand the earthquake load. Steel and brass are typically bent and/or welded to attain any given shape, whereas aluminum and acrylic parts are cut and/or adhered together to follow a pre-determined profile. Holes should be drilled through the mount at previously determined locations near the top and bottom where monofilament is inserted to secure the object to the mount as shown in figure 11. The interior surfaces should be felted and exterior surfaces finished. The mount is then secured to the display deck.

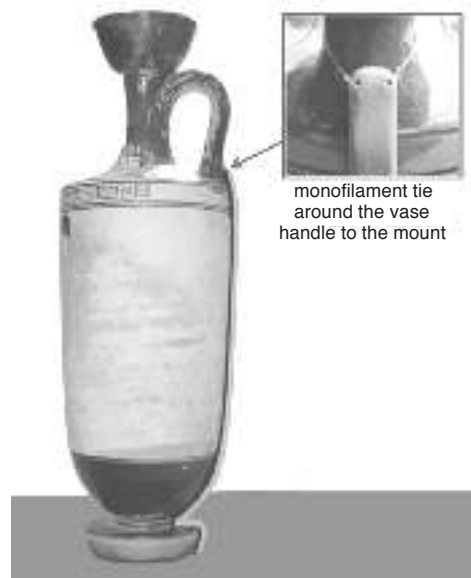

Figure 11. Monofilament tie-off to the object from the end of a contour mount.

Anchors

If an object has existing holes from previous mounting or restoration efforts, or if it is possible to safely drill appropriate holes to accommodate a mounting pin, it is advisable to anchor a mounting pin into the object using threaded anchor inserts into which the pin is threaded rather than adhered. Great care must be taken to thoroughly evaluate the fabric of the object surrounding the intended anchor points, ensuring that the material is sufficiently robust to withstand any seismic forces. Most off-the-shelf anchors have threaded interiors with knurled (roughened) exteriors. The internal threads allow fasteners to be easily removed, while the knurled exterior provides a rough texture to resist failure by pull-out.

Typically however, these anchors are designed to be press-fitted into the receiving holes. It is recommended instead that the anchors be adhered in place using a two-part epoxy. Ideally, anchors should be approximately 0.79mm smaller in diameter than the hole to assure a sufficient adhesive bond line all around the circumference of the anchor (figure 12).

Seismic base isolation (decoupling)

The discussion to this point has been limited to anchoring objects using a variety of support mounts that essentially made the object part of the structure. While this approach has a number of advantages, it also means that the seismic forces transmitted through the building will be fully experienced by the object. It also requires that either the mount be fully visible in the display or that an internal structure (often invasive to the fabric of the object) be introduced. Since this is not always possible and since objects can be too fragile to withstand the seismic load, an alternative approach is base isolation.

Isolation of structures has developed rapidly in the last several decades, but the isolation of building contents, like collections, has lagged behind.

Base isolation remains a new solution to the reduction of seismic forces. In general the isolation mechanisms and materials on which a building or an object rests are designed to absorb the motions and energies of the earthquake. Isolation mechanisms that have some form of restoring force are widely recognized as the most effective.

Decoupling, as an approach to seismic isolation, allows the floor under the object to move during an earthquake without transferring the full force of the earthquake to the object. In a sense the friction between the bottom of the object and the floor is eliminated or dramatically reduced through the introduction of low friction interfaces or mechanisms that provide limited lateral movement between the object and the floor.

There are a number of ways in which an object might be decoupled from the floor. As already described, early efforts to stabilize objects at the Getty Museum included altering the b/h ratios of pedestal/object assemblies by the addition of large steel plates to the bottom of the pedestals. These plates reduced the risk of overturning during an earthquake but did not, necessarily, stop rocking and the resultant

dynamic pounding (rocking induced impact) at the lower edges of the pedestal. Teflon pads were added to the underside of the plates to reduce friction. Theoretically these pads allowed the pedestal to slide further reducing the overturning threat and minimizing the degree of rocking. In practice however this decoupling was imperfect since rocking, even overturning, was made even more likely by encounters of the sliding pedestal with imperfections in the floor that dramatically and suddenly, increased friction.

Using a site and building study done by Lindval Richter and Associates in 1984 which identified a maximum probable event (MPE) and then provided a "design earthquake spectra," it was found that any isolation mechanism being considered by the museum would have to have a period of greater than 0.9 seconds to get any reduction of acceleration input estimated to be 0.7g at its greatest.

The longer the period of the isolator the greater the isolation as long as sufficient room for displacement is provided. However at some point displacement demands would be impractical to accommodate either for reasons of display aesthetics, limited square footage in the galleries, or safety of the visitors.

Based on the data developed from the design earthquake specific to the Getty Villa Museum differing degrees of protection can be achieved for the Getty collections by modifying certain aspects of the base isolator design. To achieve 60% isolation the mechanism must be designed with a 2 second period and to accommodate a minimum of 30.5 cm of displacement. This results in the lower portions of the object being subjected to a peak horizontal acceleration of approximately 0.3g. If the isolator is modified to accommodate 45.7 cm of displacement and designed for a period of 3 seconds, the lower part of the object will experience a peak acceleration of 0.2 g which is a 70% isolation. In both cases a 5% damping, introduced by the isolator mechanism itself, is assumed.

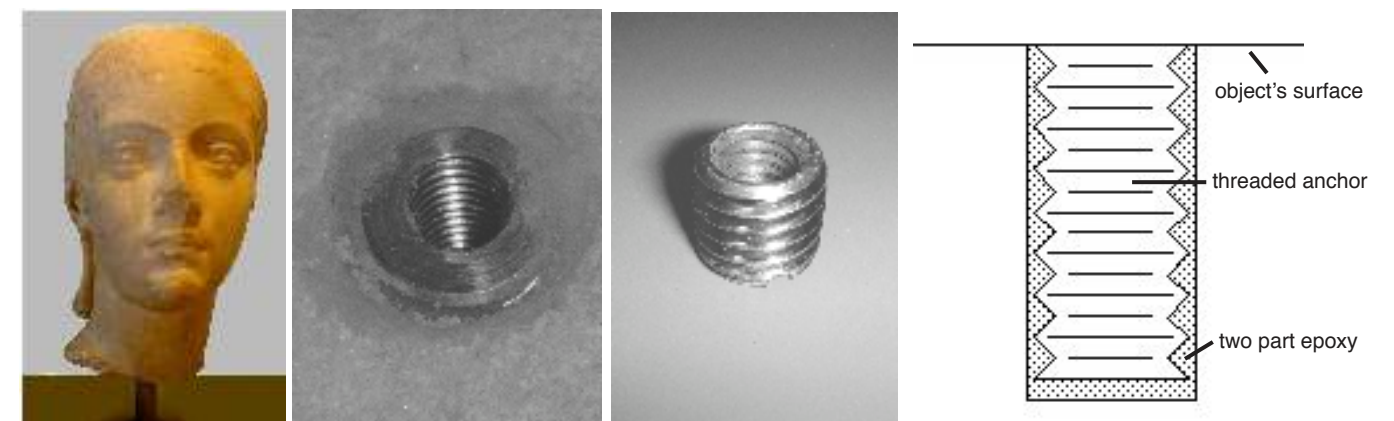

Figure 12. Threaded anchor adhered into marble head. The support pin is then threaded into the anchor.

A design originating in the museum's antiquities conservation department was tested at a commercial shake table in 1990 (sine dwell, random dwell, and simulated earthquake) and indicated that the mechanism had a natural period of 3 seconds, which when combined with an 18 inch (45.7 cm) displacement capacity provided an almost 70% reduction of the seismic forces at the top surface of the isolator. The shake table tests indicated that the isolator had a period of 2.4 Hz (approximately 4 seconds). This provided an acceptable compromise between displacement demands and size of the transmitted earthquake force.

The isolator design was fully adapted for the museum exhibits and although numerous alterations and improvements have been made, it is essentially what is used today at the Getty Villa Museum (figure 13).

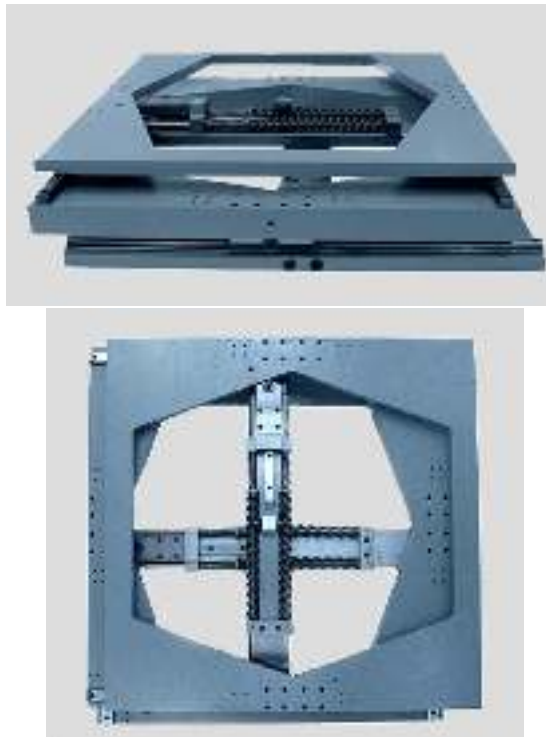

Figure 13. The isolator unit used at the Getty Villa.

The isolator is a three level de-coupling mechanism that offers relative displacement between the top, middle and bottom platforms. The top and middle platforms are supported by orthogonal sets of captured linear bearings that travel along rails. The orthogonal arrangement of these rail-bearing supports prevents torsional movements. Forces arriving at the isolator from a diagonal orientation are accommodated by a lateral "scissoring" action of the upper and middle platforms with respect to one another. The bottom frame is attached rigidly to the floor while the upper frame provides an attachment level for the pedestal, case, or object. Vertical restraint is achieved through the mechanical capture of the linear guide blocks to the rails they travel on. As a result there is no opportunity for uplift of the assembly during an

earthquake. It should be noted that since 1984, subsequent earthquakes, especially the 6.6 Richter scale magnitude Northridge earthquake which occurred on January 17th 1994 (resulting in a 0.25- 0.50g lateral acceleration and a vertical record of 0.19 g in the Los Angeles area), some assumptions have changed in seismic engineering. The more recent events have led to a re-evaluation, carried out in 2005, of the design parameters for the Getty Museum (Villa) site. As a result of this new study vertical capture is given greater attention than in the past³.

Lateral displacement of the top and middle platforms is individually limited by a centrally mounted roller for each platform that travels along an angled ramp, compressing a series of springs which provide both a predetermined resistance to the lateral displacement and a centering force to the platforms. Spring rates are pre-determined to provide a natural period between 1 and 3 seconds, the variation is determined by the available displacement. A springs-in-series design provides two specific ranges of resistance to the lateral motion. A softer set of springs provides a longer period with less resistance. As maximum displacement is approached the stiffer set of springs offers greater resistance in order to accommodate larger earthquake forces and to avoid a sudden stop as the maximum displacement is reached.

During the 1990 testing the isolator was attached to a full-scale model of the object being considered for exhibition. The weight distribution of the model accurately mimicked that of the original sculpture as did the approach to assembly of the object's fragments and attachment to the base and isolator. The 100% design earthquake (maximum probable event, MPE) motion was filtered to remove periods greater than 4 seconds to insure that the maximum displacement of the table would not be exceeded. Although some whipping at the top of the sculpture-model was experienced, the top of the sculpture displaced with a max excursion of 2.5 inches (6.3 cm). The predicted 0.7 g peak was reduced to 0.1 g at the top of isolator (a 70% reduction), 0.15g at the top of pedestal (60% reduction), and 0.3g-0.4g (a 35% - 45% reduction) at the top of the sculpture.

Since the isolator was designed for a full 45.7 cm displacement, ample reserve was provided by the design. Realistically however this amount of displacement is not always possible due to the limitations of gallery space, aesthetic proportions of pedestal to object size, and safety of the visitor should the isolator and ground experience displacement while the visitor is standing in close proximity.

It should be noted that while isolators absorb a given percentage of the seismic forces, they can never eliminate the need for seismic mounts and structurally robust exhibition furniture.

Casework

The structural design of exhibition casework is a critical component in any effort to mitigate seismic damage to exhibitions. Display cases and pedestals must be sufficiently stiff and structurally strong, designed to withstand dynamic

forces beyond the predicted event while remaining intact and securely anchored to the building. As a general rule of thumb designing for a force of 3g (which includes a safety factor of 3 or more) meets a wide variety of needs. The design of a case or pedestal structure should provide direct support under the display surface and artwork (figure 14). This support structure should be rigidly connected to the structural elements of the case or pedestal. The casework structure should include attachment points to either the building or an isolation system.



Figure 14. An aluminum structure supporting a large sculpture. The frame is then covered with a facing for display.

Anchoring casework

Anchoring the casework to the floor or wall is always the best choice, since this fixes the artwork and display furniture firmly in place resulting in a synchronous movement of the object with the casework and the casework with the building. It is important however that these anchoring points and the hardware used is sufficiently strong to resist the forces imposed on them during an earthquake.

Conclusions

Many of the suggested solutions outlined in this paper for the protection of collections from seismic threats have concentrated on exhibition conditions. It should be kept in mind that the majority of many collections are not on display, but rather placed in storage areas where the threat of seismic damage can be just as great, if not greater (due to density) than in the galleries.

The concepts of mitigation presented here work equally well for storage facilities, where mitigation efforts can be applied with less concern for aesthetic presentation. Tying objects to shelves that have been firmly secured to a wall; placing large restraining lips or ledges along the length and outer edges of shelves; and placing soft buffering foam pads between objects in close proximity or carving individual cavities in

large blocks of ethafoam for storage are all effective ways of protecting stored collections. None are excessively expensive, nor do they necessarily need extensive engineering studies to carry out.

The efforts to protect collections from earthquake damage continually evolve, as do seismology and our understanding of the nature of earthquakes. It will only be through close collaboration that we will advance the efforts of preservation and reduce the number of collections that may suffer from inevitable earthquakes yet to come.

REFERENCES

1. Lindvall Richter and Associates. *Geologic and Seismic Safety Evaluation of the Main Museum Building for the J. Paul Getty Museum, Malibu, California*. (1984). Internal report on file at J. Paul Getty Museum, Department of Antiquities Conservation.
2. URS Corporation. *Ground Motion Response Spectra and Time Histories, Getty Museum, Malibu*, (2005). Internal report
3. Agbabian, M.S., Masri, S.F. and Nigbor, R.L. *Evaluation of Seismic Mitigation Measures for Art Objects*, GCI Scientific Report. J. Paul Getty Trust Publications, 1990, Los Angeles.

Tool/Supply Sources

- McMaster-Carr Supply Co. (almost everything) mcmaster.com
- MSC Industrial Supply Co. (almost everything, good epoxy source) mscdirect.com
- Tool Crib of the North (tools) toolcribofthenorth.com
- Micro-Mark (small hand tools) micromark.com
- Rio Grande (jewelers supplies) riogrande.com
- Benchmark (mountmaking supplies) benchmarkcatalog.com
- University Products (conservation supplies) archivalsupplies.com
- Conservation Support Systems silcom.com
- Conservation Materials, Ltd. (800) 733-5283
- ITW Philadelphia Resins (Phillyseal R, epoxy putty) philadelphiarresins.com

Helpful References

- Pocket Ref*, Thomas J. Glover, Abbeon Cal, Inc.
- Machinists' Ready Reference*, Clarence Weingartner, Pranken Publications.
- Machinery's Handbook*, Erik Oberg, Franklin Jones, and Holbrook Horton, Industrial Press Inc.

The J. Paul Getty Museum at the Villa will hold a Mount Making Forum, on March 28th, 2008. For more information contact MDLowry@getty.edu.

Articles You May Have Missed

“A Splash of Photo History Comes to Light,” *New York Times*, 05/21/2007

The George Eastman House in Rochester, New York, one of the world’s leading photography museums, has received two Edward Steichen autochromes. They are among the few surviving masterpieces from the earliest days of color photography.

They were taken by Steichen, probably in Buffalo, and are thought to be portraits of Charlotte Spaulding, a friend and student who became his luminous subject for the portraits. As far as anyone knows, the photographs were never displayed and were kept in a cupboard or closet for decades. Because the photographs had sat for so long out of the light, their colors remained particularly vivid.

Autochromes are positive images, made using a complex process in which tiny dyed grains of potato starch were spread across a piece of glass and light was passed through them to a photo-sensitive plate. Unlike most other antique prints, autochromes are usually displayed with a light source behind them, allowing their colors, which are dim in regular light, to shine through the semi-transparent glass or to reflect onto a mirror. But prolonged exposure to light can wash out the images.

After Eastman House displays the pictures they will be returned to storage. (The pictures will be exhibited on a light table sometime in October, although a date has not been set.)

“Murals, a Floor-to-Ceiling Fantasy,” *Los Angeles Times*, 05/31/2007

In the design empire of Los Angeles, where Modern is king and where clean lines and empty spaces have come to define so many castles, it’s something of a surprise to see a resurgence of frescoes, murals, and other painterly effects.

Today, that fantasy isn’t bound by Tuscan landscapes, trompe l’oeil, and other traditional works that may make Modernists cringe. Artists are delivering bold, abstract statements and unconventional color. The result is not so much the revival of an old art form but the reinvention of it.

Painter Darren Waterston believes the origins of wall murals here can be traced to the movie industry’s penchant for storytelling and the desire to give spaces a pictorial narrative. The

movie colony routinely hired the same scenic painters who worked on movie theaters and set designs to create picturesque imagery in homes.

Anthony Heinsbergen, whose commissions included Los Angeles City Hall, the nearby Biltmore hotel, and virtually every movie theater downtown, carried the highest profile. In the 1930s, filmmaker Dudley Murphy offered an exiled David Alfaro Siqueiros sanctuary in Hollywood, and in return Murphy received a hand-painted fresco for his Pacific Palisades backyard. Frescoes tend to last longer and retain their vibrancy better than some other techniques, but they can be expensive — upward of \$25,000 for a small wall.

“World War II Glider Restoration,” *WLUC-TV* (Michigan), 06/10/2007

A World War II glider that was discovered in Dickinson County, MI three years ago is well on its way to being restored to its original glory. Recovered from the Vernon Anderson Farm in Felch, the CG4A Glider is now in two different states. Part of the fuselage, the nose section and the center section is down in Wausau, WI. The other half of the glider—the wings and tail end—are being restored in the dry building next to the Cornish Pump in Iron Mountain, MI.

“There are only four fully-restored gliders in the world that we’re aware of, so we’ll be the fifth,” said project director Ken Sovey. “This is very unique.” Volunteers will reconstruct the glider with 2,000 pages of plans. The fuselage should be completed in the next two to three years and the entire glider in five years.

“Huge Project to Restore Italian Palace’s Glory,” *The Guardian*, 06/11/2007

For more than half a century, one of the world’s biggest and most historically important gardens was left to degenerate into a wilderness.

The Reggia di Venaria Reale outside Turin is said to have provided Louis XIV with the inspiration for his palace at Versailles. But, by the end of the 1990s, the 80 hectares (200 acres) of land surrounding it had become little more than a wasteland. The geometric paths that criss-crossed the grounds were overgrown. The flower beds were lost under weeds. As for the vast, 250-metre-

long fish pond, it had long since dried up and was barely discernible.

But yesterday, after eight years of painstaking work and a budget of 25m (£17m), 25 hectares of the reconstructed gardens were reopened to the public. The restoration of the grounds is just one aspect of the 200m project to restore the complex. It is planned to reopen parts of the palace, or reggia, itself in September, but the entire scheme is not expected to be completed until 2011.

The Reggia di Venaria Reale was built as a summer residence and hunting lodge for the ruling family of the vanished duchy of Savoy and was begun in 1659. Like Versailles, part of its purpose was to inspire awe: the main building alone is bigger than Buckingham Palace.

“Marty Gives Film Restoration a Fillip,” *The Financial Express*, 06/10/2007

The need to step up efforts to save endangered films has never been greater. Martin Scorsese has given the mission a global thrust. One key development on the sidelines of the recently concluded 60th Cannes Film Festival was the formal launch of the World Cinema Foundation (WCF) under the chairmanship of filmmaker Martin Scorsese. The most interesting aspect of the initiative, aimed at the preservation and restoration of the world’s film heritage, is that it involves the active participation of leading filmmakers from every continent of the world.

“Paintings from New Orleans Spared by the Storm,” *Omaha World-Herald*, 06/10/2007

John Bullard, the director of the New Orleans Museum of Art, was on vacation in Maine when Hurricane Katrina hit in August 2005. The day after Katrina, his museum overlooked only a giant lake. Half of the museum’s sculpture garden was submerged. Cracks in the museum’s foundation gurgled water.

Workers agreed to live in the museum with their families during the hurricane, sleeping in offices and protecting the collections. From Maine, Bullard hired a private security team, which finagled its way back into the closed city and rode flat-bottomed motor boats through the flooded streets to the museum. What they found was shockingly encouraging.

Apart from a few damaged items, the vast majority of its renowned collection was fine. All told, the museum suffered only about \$5 million in damage. But the worst was yet to come. By the time it reopened in December, the museum’s monthly attendance had dipped from 12,000 to 5,000.

To make budget, the museum laid off 85 of its 100 employees. To raise money and awareness, the museum sent its top works to New York for an exhibit at the Wildenstein & Co. gallery. At the same time in Omaha, Joslyn Art Museum director Brooks Joyner worked out a deal to bring the show of the New Orleans Museum of Art’s top works to Nebraska.

In return for displaying works by Monet, Picasso, Pollock and more, the Joslyn agreed to give the New Orleans museum \$100,000. A private conservator in New York offered to donate his time to repair special works from the museum’s collection. He targeted one of the most important works in the collection, Edgar Degas’ *Portrait of Estelle Musson De Gas*, which had not left New Orleans in the forty years the museum has owned her.

“Fountains of Rome May Dry up after Builders Sever Pipe,” *The London Times*, 06/13/2007

For 2,000 years the Trevi Fountain in Rome has provided a constant influx of fresh water for one of the most fabled sites in the city. Now, with summer around the corner, the supply has dried up — and it has nothing to do with global warming.

Water engineers blame the reduction to a trickle on damage to underground conduits caused by work on a suburban garage. The builders say that they were assured that no archeological remains lay beneath the site.

The severing of the Aqua Virgo has highlighted the remarkable extent to which Rome depends on engineering from two millennia ago. Its absence has also dried up fountains in the Villa Borghese Gardens, the main park in Rome, as well as on Piazza Colonna in front of Palazzo Chigi, the Prime Minister’s residence, and at the Pantheon.

Unlike many other Roman water supplies, which were carried above ground, the Aqua Virgo ran largely in

conduits beneath the surface and thus survived the neglect of the Middle Ages, when many Roman overground aqueducts collapsed.

Officials said that work on the underground garage at a villa in the suburb of Parioli had ruptured the pipes carrying the water. Workers, apparently not realising the consequences, had blocked the conduits with cement and rubble.

“Henry Ford Museum Carousel,” *The Carousel News and Trader*, 06/16/2007

The carousel in Greenfield Village was built about 1913 by the Herschell-Spillman Company in North Tonawanda, NY. During the early 1900s, Herschell-Spillman made more carousels than any other American factory. The Henry Ford Museum purchased the carousel in 1973.

The carousel has 40 hand-carved animals: eight of the animals are stationary and 32 are jumpers, animals that move up and down when the carousel is in operation. The carousel also includes two stationary chariots, one rocking chariot, and a lovers tub.

By the time the Henry Ford Museum and Greenfield Village purchased the carousel it had been through decades of operation and was in dire need of restoration. Local carousel restorer Tony Orlando was contracted to work on the carousel figures over 30 years ago and again recently in a new restoration program.

Two or three figures are being removed from the carousel each year so that they can be given a complete and historically-correct restoration. The museum’s philosophy is to preserve the figures in their original color schemes so whenever possible, Tony is revealing traces of original paint and recording the colors using a Munsell Color chart. Old layers of paint are painstakingly scraped away to reveal the original paint and if found to be intact, the animal is sealed for protection and repainted in the same colors.

“The Long and Winding ‘Road’,” *The Boston Globe*, 06/20/2007

Jim Canary was nervous. In the morning, the conservator would be flying to Boston with his steady travel companion, the fragile, \$2.43 million scroll on which Beat icon Jack Kerouac ham-

Susanne Friend, column editor

mered out “On the Road.” The scroll, yellowing and mounted on two Plexiglas spools, went on display last week for the first time in Lowell, Mass., Kerouac’s hometown, as part of an exhibition at the Boott Cotton Mills Museum celebrating the 50th anniversary of the book’s publication. But before coming to Boston, the scroll would have to get through a photo shoot for Vanity Fair.

That’s how Canary found himself just north of Indianapolis earlier last week, delivering the delicate document to millionaire Colts owner Jim Irsay, who bought the scroll in 2001 and loves photo ops with it.

Kerouac made the scroll by taping together rolls of art tracing paper so he could work without interruption on the book, which chronicles his travels with road buddy Neal Cassady. When the scroll went up for auction, Canary realized it would be too expensive for the university’s rare books library in Bloomington to purchase. Then after the sale, Irsay called looking for assistance. In return, Canary says, Irsay has given generously to the library.

While in his possession, the scroll stays in a special box in a climate-controlled vault at the library. Irsay doesn’t operate by the same rules. Press opportunities have created some memorable moments. For one article, Irsay decided he wanted to pose with the scroll wrapped around his body. For another, he choreographed a scene in which he held a pair of scissors to the paper and Canary simulated a punch to the jaw.

“That’s where my Buddhism comes in,” says Canary. “Some conservators would have walked off. I talked to him about it.”

“Home Fit for a Queen after Grand Makeover,” *Evening News*, Scotland, 07/20/2007

Like an aging Hollywood starlet, East Lothian stately castle Lennoxlove House has undergone a massive nip and tuck, emerging looking glossier and, in some rooms, more modern than ever.

To complete the transformation, the once private abode of the Duke and Duchess of Hamilton is now available to rent, if you can afford the £7000 starting price. For the first time, paying guests with a big enough bank balance can now take over the entire 700-year-old Len-

noxlove House and estate, taking up residence in 11 bedroom suites. Without the extensive refurbishment and rebirth as a commercial operation, the grand home of Scotland's premier peer - the duke is the Queen's representative in Scotland - may well have crumbled. Dry rot had gnawed away upper areas of the grand home before conservation architect Alison Smith arrived on the scene last year to start work.

The refurbished house will open to the public for just three days a week - a requirement set down by financial backer Historic Scotland as part of its £524,000 grant. It will close its doors for the remaining days for corporate guests and wealthy private individuals. All will have the chance to gaze on one of Scotland's best private art collections featuring works by van Dyke, Raeburn, and Kneller; antiquities and curios including the famous death mask and a sapphire ring belonging to Mary, Queen of Scots; a selection of garter robes, among them one that belonged to the Duke of Lennox, discovered six years ago.

“Buffalo Bill: Lockport Woman Completing Restoration on 1878 Billboard,” *Lockport-Union Sun & Journal*, 07/22/2007

Buffalo Bill is coming alive in the Town of Lockport. Laura Schell, a member of Buffalo State College's prestigious Art Conservation program, began restoring the unique 1878 billboard which promotes a “Buffalo Bill” Cody stage show which took place in Jamestown 129 years ago.

The paper conservator, who is working at her home, hopes to have the job completed in the fall. The billboard was discovered by workers beneath the crumbling brick facade of a former hotel on Pine Street in Jamestown in 2002. Construction workers were tearing down the brick facade of an old building that was right down the street from the Lucille Ball museum.

Schell was contacted for emergency removal in June 2002. “As the bricks came down, they could start seeing faces. They could see Buffalo and stopped all work,” Schell said. “They’ve got witnesses saying they saw pieces of it blowing down the street. By the time I got there it was really in rough shape.

Pieces were falling off the wall.” “It is thought to be one of the oldest, if not the oldest existing billboards in the states. It’s a very rare artifact.”

“Painting Meets its Femme Fatale,” *BBC News*, 07/21/2007

A woman who says she was so overcome with passion for a valuable painting on display in France, has been charged with criminal damage after kissing it.

The immaculate white canvas so attracted Sam Rindy she smudged it with her lipstick, saying later she had wanted to make it even more beautiful. The 3x2m (9x6-foot) painting by US artist Cy Twombly is valued at more than \$2m (£970,000). Ms Rindy, herself an artist, is due to appear in court on 16 August.

Staff at the Collection Lambert museum in the southern French city of Avignon alerted police after the incident on Thursday afternoon, and she was arrested as she was walking out. “A red stain remained on the canvas... This red stain is testimony to this moment, to the power of art.” Speaking to French news agency AFP, she said the artist had “left this white” for her.

“Graffiti House Good Soldiers, Bad Artists New Scribblings Revealed,” *The Free Lance-Star*, 7/23/2007

While removing paint from the walls of Brandy Station's Graffiti House in Culpeper County this weekend, conservation technician Kirsten Travers uncovered a horse with a neck that would seem more appropriate attached to a brontosaurus.

Travers is working under a \$15,000 Virginia Department of Human Resources grant the Brandy Station Foundation received earlier this month. The matching grant, according to Della Edrington of the BSF, will allow the foundation to bring in experts such as Travers to determine what restoration works need to be done to save both the Graffiti House and the dozens of charcoal and graphite scribblings on its inside walls.

That graffiti, which includes the names, military units and hometowns of a number of the soldiers who were housed there when the structure was used as a field hospital, is a part of Civil War and

Culpeper County history that the BSF desperately wants to preserve.

“Floods Threaten Ancient and Historic Sites,” *Guardian Unlimited*, 07/27/2007

Rain was falling remorselessly on Silbury Hill, seeping down into the core of the most enigmatic prehistoric monument in Europe. The entire hill near Avebury in Wiltshire is artificial, built around 4,500 years ago by stupendous human effort with an estimated 35m baskets of chalk.

The engineering contractors Skanska, who were carrying out structural repairs for English Heritage, pulled its miners off the hill on Monday, fearing that the 40-year-old tunnel in which they were working might collapse.

Silbury's purpose - observatory, ritual platform, or simply awe-inspiring demonstration of power and wealth - is still guesswork. No original chamber or passage has ever been detected. The site is wreathed in folklore of treasure hoards, which have attracted centuries of treasure-hunters.

In floods five years ago, a chasm opened at the top of the hill, where a poorly filled 200-year-old shaft collapsed, and water poured down into the structure, seeping into voids left by generations of later diggers, including the tunnels from a major excavation in the 1960s.

The plan, now left in chaos by the weather, was to empty those tunnels completely of their previous loose fill, and then pack them solidly again with chalk. Instead rain is still seeping into the mound, from the summit where the earlier domed repair has already partly washed away, causing damage which can't even be fully assessed until the rain stops.

“A Painting with a Contested Past in the Nazi Era Makes its Way to NYC,” *The Boston Globe*, 07/27/2007

Berlin Street Scene by Ernst Ludwig Kirchner is now on display at the Neue Galerie museum. A garish painting of Berlin streetwalkers on the prowl, the subject of a bitter restitution case from the Nazi era, went on display at the museum that bought it for \$38.1 million in frenzied bidding.

Until recently, this modernist masterpiece had hung in Berlin's Bruecke Museum, acquired in the early 1980s from private German owners. But last summer, the Berlin government returned it to the London heir of Jewish art collector Alfred Hess, whose widow had sold off the works during the 1930s after the family shoe business was expropriated by the Nazis.

Berlin city officials said restitution was an act of historical justice in line with other hand-overs of art lost by Jewish owners to confiscation, theft, or forced sale during the Nazi period and World War II. But German critics contended that the Hess family's decision to sell the painting in the 1930s resulted from their financial troubles during the Depression -- not actions by the Nazis. They said ownership of other works held by German museums could now be threatened under the expanded interpretation of what constitutes Nazi-confiscated art.

“Compliment Machine Gives Artful Praise,” *Los Angeles Times*, 07/28/2007

A woman pushing a stroller across the street in the 92-degree heat is met with aggressive honks from hurried drivers. One of her sandals is chafing her heel and her baby has spit his pacifier onto the pavement. But things are just about to look up. A 5-foot-high red-and-white-striped box dings as she walks by, and a disembodied voice says: “You have changed for the better.” At first, the look on her face is bewilderment. Then, slowly, it changes to a smile.

The box, known as the Compliment Machine, is part of SiteProjects DC, a collection of outdoor exhibits by 16 artists along six blocks of 14th Street Northwest. Of all the installations, the machine has been the biggest success - and has garnered attention for its creator, Tom Greaves. Inside the wooden box is an iPod Nano with 100 recorded compliments that play at random.

Greaves recorded the compliments in a flat, unaffected tone and allowed varying amounts of dead air after the recordings so that passersby wouldn't know when to expect the next compliment. “You are awesome,” the machine says, following up quickly with, “You are a great driver.” (That one was lost on

a confused man riding his bike past an adjacent construction site.) “People are drawn to your positive energy.” “You have a nice voice.”

“Forger Back at Work - and This Time It's All above Board,” *The Guardian*, 07/30/2007

Britain's most notorious living art forger, Robert Thwaites, also known as Prisoner XA5833, is back at work. Ten months ago, Thwaites was jailed for two years for audacious frauds that stunned and embarrassed the art world.

Desperate for money, the jobbing artist created paintings and passed them off as the work of John Anster Fitzgerald (circa 1823-1906), who conjured visions of a fairyland full of menacing spirits. After exposure and conviction, Thwaites, 55, went down in disgrace although even the judge hailed his “remarkably talented” work.

Released on licence but under strict supervision, he is painting once more in the style of Fitzgerald. But, older, thinner, and greyer, he said he now hoped to use his skills and the additional notoriety to create a legitimate career.

His first painting was faked and sold so Thwaites could pay private school fees of £54,000. Another painting, which did not sell, was conceived to raise cash for his brother, Brian, who is seriously ill and uses a wheelchair.

“I knew it was wrong but I wasn't scared,” said Thwaites. “Just because I got caught doesn't mean I failed. I procured for my son the best education money can buy.” His latest Fitzgerald-style painting, *The Release*, is painted on hardboard, so there can be no dispute about its origins.

“Baghdad Museum Reopens to Staff,” *The Art Newspaper*, 08/02/2007

The Baghdad Museum, which has been sealed with concrete, is to be reopened to staff. Shortly before antiquities head Donny George went into exile last August, he had all the entrances to the building blocked, because of the deteriorating security situation in Baghdad.

Dr. George admitted that this could have created environmental problems, but he felt it was too dangerous to protect the museum with just locked doors. Dr. Abbas al-Hussainy, the new director of the state board of antiquities,

told *The Art Newspaper* last month that he is now “very worried about underground water.” Ivories and cuneiform tablets would be particularly vulnerable. There are also concerns that rats may have multiplied in the museum over the past year.

After facing the dilemma of having to balance security and environmental risks, Dr. Abbas has decided that the building should be reopened to staff. In the current security situation, there is no immediate prospect of the museum being open to visitors. The Italian government recently provided a massive steel security door for the Baghdad museum. Last month a gap was breached in the wall and the new door was cemented into place. Beyond the security door there are two further locked doors, which have not been entered, so conditions inside the stores remain unknown.

“Hidden van Gogh Found at MFA,” *The Boston Globe*, 08/04/2007

For years, art scholars pondered a mystery: Did Vincent van Gogh create a painting that matches a sketch in Amsterdam's Van Gogh Museum? Now a conservator at the Museum of Fine Arts has discovered the lost painting, but museum-goers will never be able to see it:

The painting lies underneath another van Gogh long on display at the MFA. The Dutch master created the lost painting, *Wild Vegetation*, in 1889, during his stay at an asylum near Saint-Remy, France. The hidden work was found by chance when conservator Meta Chavannes X-rayed the MFA's painting, *The Ravine*, about a year ago as part of a research project.

By chance, Chavannes, who is Dutch, was heading home to Amsterdam to visit family. She made an appointment with Louis van Tilborgh, a curator at the Van Gogh Museum. He immediately recognized the image as being similar to a drawing in the museum's collection. A report on their discovery is being published this week in *The Burlington Magazine*.

“Uffizi Expansion Goes Ahead Despite Florentine Opposition,” *The Independent*, 08/10/2007

The plan to add a huge new modernist portico to Florence's Uffizi Gallery, the most controversial building

project of recent times in Italy, is to go ahead. After nine years of bitter argument and despite the rage of Florentines including the opera and film director Franco Zeffirelli, the dramatic and imposing new portico at the side of Italy's most famous art museum was given approval this week.

Its designer is Arata Isozaki, the celebrated avant garde architect from Kyushu. His solution was simple, bold, and arresting: a huge cantilevered canopy fanning out from the gallery, supported by slim rectangular pilasters. There was no attempt to integrate the new work with the Renaissance original: the contrast between old and modern was deliberately stark.

The last large modern building to be erected in Florence is the station, which dates from 1935. But the reaction of conservatives was ferocious. Oriana Fallaci, the Florentine journalist and novelist, called the design "absolutely indecent and unheard of," and threatened to return to Florence from her home in New York "and tear it to pieces with my bare hands."

The architect now expects building work to start in the autumn, and for the structure to be completion by 2011. But the project's opponents will not give up without a fight.

"Inglewood's Famed History of Transportation Mural makes a Bold Comeback," *Los Angeles Times*, 08/11/2007

Sixty-seven years after it was installed in Inglewood, with great fanfare, and six years after it was removed for restoration, in deplorable condition, Helen Lundeberg's massive WPA mural *The History of Transportation* has a new home. The 60-panel, 240-foot-long artwork runs along a curved wall in the new Grevillea Art Park, close to Inglewood City Hall and High School.

This is quite a comeback for the mural, which was badly battered and disfigured before it underwent treatment at Sculpture Conservation Studio in West Los Angeles. Made of petrachrome, a terrazzo-like material composed of crushed rock embedded in tinted mortar, the artwork was built to last. But two panels were destroyed by wayward vehicles; others were cracked, and buried under layers of graffiti.

Lundeberg, a Los Angeles-

based artist who died in 1999, at 91, was commissioned to make the mural by the Work Projects Administration's Federal Art Project. She designed the panoramic view of the evolution of transportation -- from Native Americans on foot to passengers boarding a DC-3 aircraft -- for the entrance to Centinela Park (now Edward Vincent Jr. Park).

Conservation began in 2003 and was finished in a couple of years. Then came the challenges and inevitable delays in installing the work exactly as it was in 1940. Finally on view again, the softly colored parade of people walking and riding into the future can be seen up close with surfaces cleaned, cracks filled, and the two missing panels replaced by facsimiles in colored cement.

"Getty Museum to Give Back Forty Works of Art to Italy," *Agenzia Giornalistica Italiana*, 08/13/2007

The deal to return forty works of art was made by the minister of Cultural Activities, Francesco Rutelli, and the general director of the J. Getty Museum, Michael Brand. The agreement includes the following points: - The Getty transfers 40 objects to Italy, including the Cult Statue of a Goddess. Technicians from Italy and the Getty Museum will decide on a timeframe for the transfer of the objects in the coming months, with the exception of the statue which will stay in the Getty until the end of 2010.

The parties agree to refer further discussions on the statue of a young victorious athlete to the legal steps in progress in Pesaro. Italy and the Getty agree on a broad cultural collaboration that will include loans of important works of art, joint exhibitions, research and conservation, and restoration projects. Both parties "are pleased that, after long and difficult negotiations, an agreement was reached and now proceed to a new relation of collaboration".

"Next Restoration: The Sarcophagus of the Married Couple," *RomaOne.It*, 08/14/2007

Housed in the Etruscan Museum of Villa Giulia and originally from Cerveteri, the masterpiece in terracotta is the next goal after the restoration of the Hercules of Veio. Discovered in a tomb of the necropolis of Banditaccia of Cerveteri and dating from around the 6th-5th century

B.C., *the Sarcophagus of the Married Couple* is one of the principal attractions of the museum and one of the most famous examples of Etruscan plastic arts. Witness to a love that has lasted more than two millennia, the cover of the sarcophagus represents a life-size couple reclining on a dining couch in an attitude of tender affection. The conservation is to be sponsored by the Federazione Italiana Tabaccai.

"Restoration Proposed for the 'Casiceddhre di Noha'," *Edil One*, 08/22/2007

The so-called "Casiceddhre," or houses of the dwarves, are miniature buildings in polychromed Lecce stone. They are of significant historic, artistic, and cultural importance and may be found in Noha, near the baroque city of Lecce in Puglia, Italy.

The tiny buildings constitute the faithful reproduction in miniature of sixteenth century palaces. Rich in architectural detail, they are considered a rarity among scholars and historians. Cracks in the paving surrounding them and in the building below as well as weeds and roots from nearby pine trees are threatening the tiny buildings. It is not known who constructed these little architectural gems.

"British Library Uncovers Missing Constable," *The Guardian*, 08/24/2007

A lost sketch by John Constable, never recorded in the catalogues of his work, has tumbled with a cascade of other drawings and letters from volumes which the British Library has owned for almost a century. The library has only just appreciated the scale of its bequest from John Platt, a wealthy textile manufacturer who became a serious art collector, who died in 1902, leaving many of his magnificently bound volumes to the British Museum.

The delicate little pencil drawing of Hyam Church in the artist's native Suffolk, bought from his grandson 50 years after his death, has been hidden among the pages of one of the books ever since. The Constable, some of the other drawings and documents, and some of the volumes themselves, will now go on display in the library's Treasures gallery.